

- 2.9 Only for sectional and spring operated garage doors**
Fasten the draw slide **I** on the upper portion of the door maintaining the previously marked reference points.
Connect the perforated bar **L** and the curved arm **M** using 2, 6 x 15 bolts. Connect the curved arm **M** and the draw plate **I** using the cylindrical headed pivot with the provided split pin.

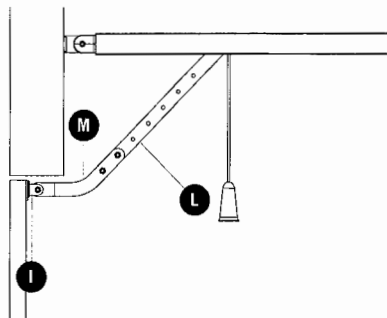

- 3. Only for counter-weighted garage doors**
Fasten the arch arm **162504** on the upper portion of the door maintaining the previously marked reference points.
The two anchor plates (upper and lower) of the arch **162504** must be in the same plane. If not, add shims.
Connect the perforated bar **L** to the perforated bar of the arch arm using 2, 6 x 15 bolts.

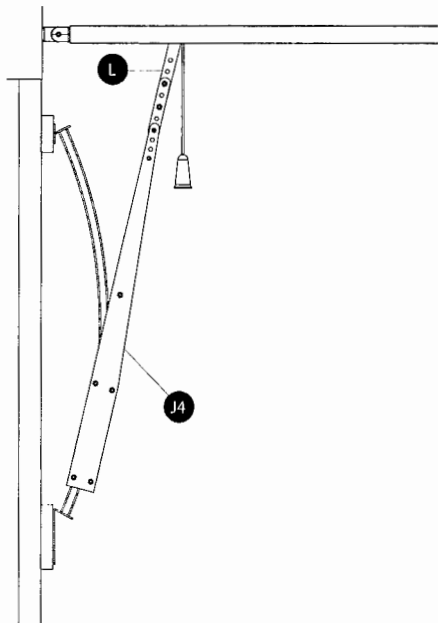

RELEASE OF THE AUTOMATION

In order to release the automation from inside, pull the knob downwards.

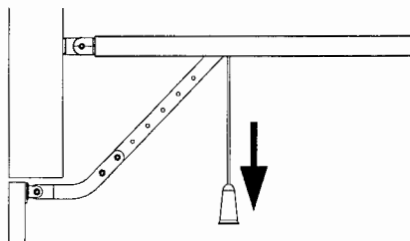

⚠ CAUTION: Do not use the knob to open the door. It is prohibited to hand objects off the release cord.

In order to release the automation from outside, install the accessory release kit (code **162518**).

ELECTRICAL CONNECTIONS

The control panel inside AZIMUT is already cabled. You just need to plug it in the electrical outlet to proceed with operational parameter programming.

To connect the photocells and the START button, please refer to the following diagram:

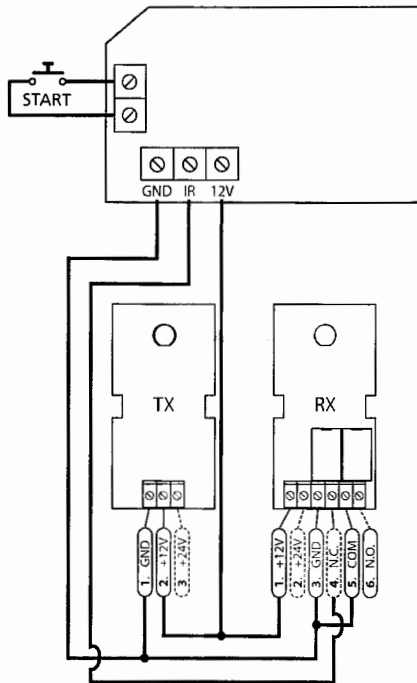

SET-UP OF OPERATIONAL PARAMETERS

AZIMUT is equipped with a practical interface that allows rapid and simple on-display programming

using four keys: , , +, -.

Preliminary operations:

1. Move the door so as to hook on the drive trolley.
2. Power up the device: the courtesy light comes on, the control unit emits a BEEP and the segments of the display are illuminated one at a time until the display shows 0.

⚠ PLEASE NOTE: if programming is not completed (by means of function 9. End programming) the parameters set are lost. If there is an error in the set parameters, simply power off the device, restore power and then repeat the programming operation.

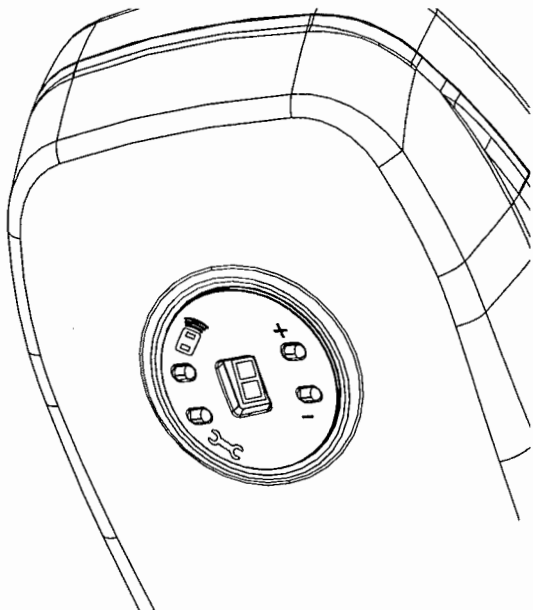

1. Setting the open limit switch

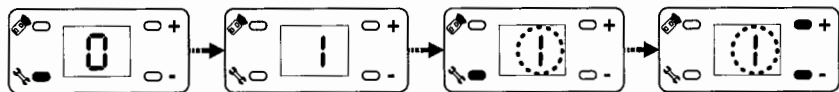



Press the  key for 5 seconds

The device emits a beep and the display shows 1

Press the  key: 1 flashes

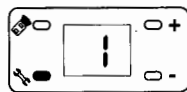
Press and hold the + (the door opens) or - (the door closes) key to reach the fully open position



When the door reaches the desired position, press the  key to save the settings

⚠ PLEASE NOTE: The open limit switch must be stored prior to the close limit switch. If this procedure is used erroneously to set the close limit switch, the parameter is NOT stored.

2. Setting the close limit switch

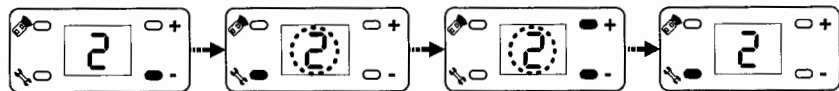

Press the - key, the display shows 2

Press the  key: 2 flashes

Press and hold the + (the door opens) or - (the door closes) key to reach the fully close position

When the door reaches the closed position, wait 2 seconds, then press the  key to save the settings

3. Self learning of the forces

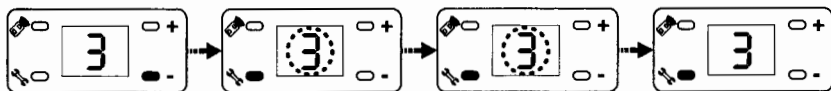

Press the - key,
the display shows 3

Press the key:
3 flashes - the door opens

When the door stops, press
the key to confirm.
Press the key once more
to continue - the door closes

When the door stops, press the
key to save the settings.
The display shows 3

PLEASE NOTE: On completion of the procedure, it is possible to exit the programming procedure, storing the parameters set: press and hold the key for 5 seconds until the segments of the display illuminate one at a time until showing 0

4. Adjusting the sensitivity (default: 4)

This menu allows the sensitivity of the device, when the door encounters an obstacle, to be increased or decreased. This parameter is already set to a mid value (4) that should be ideal for the majority of installations.

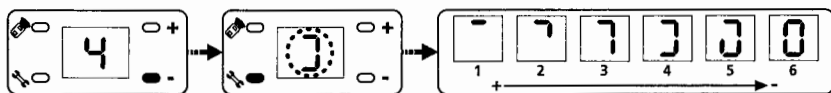

Press the - key,
the display shows 4

Press the key:
4 flashes

Select the desired level using the + and - keys

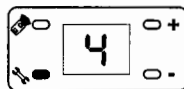

Press the key to save
the settings: the display
shows 4

PLEASE NOTE: if this parameter is modified, then on completion of programming, it is necessary to conduct a complete open/close cycle, during which the control unit automatically conducts a fresh force training operation (during this cycle, the motor works at maximum force, so particular attention must be paid).

5. Remote control button selection (default: 2)

This menu allows selection of the button to be used for controlling the automation system. This function may be useful where it is desired to control several different automation systems using different buttons on the same remote control.

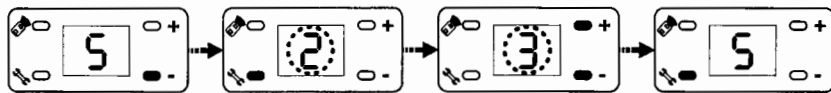

Press the - key,
the display shows 5

Press the key: 2 flashes
to indicate that the 2 key on
the remote control unit
controls this motor

Press the + or - key
to select the desired key.

Press the key to save
the settings: the display
shows 5

6. Open alarm (default: 0 – function deactivated)

If this function is activated, the device emits BEEPs for 30 seconds when the door remains open for longer than 10 minutes. The alarm is repeated every 10 minutes. Close door to interrupt the alarm.

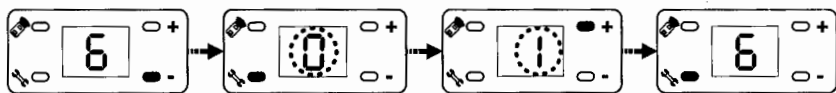

Press the - key,
the display shows 6

Press the key: 0 flashes
to indicate that the function
is deactivated

Press the + key to activate
the function: the display
shows 1

Press the key to save
the settings: the display
shows 6

7. Automatic closure (default: 0 – function deactivated)

If this function is activated, the device automatically closes the door after the set period of time. Prior to closing the door, the device emits BEEPs for 20 seconds.

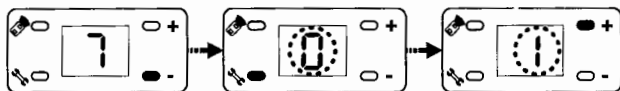

Press the - key,
the display shows 7

Press the key: 0 flashes
to indicate that the
function is deactivated

Press the + key to activate
the function: the display
shows 1 corresponding to
30 seconds

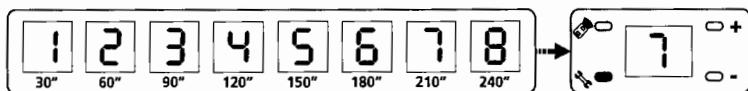

Select the desired pause time using the + and - keys

Press the key to save
the settings: the display
shows 7

8. Maintenance alarm (default: 0 – function deactivated)

If this function is activated, the device emits BEEPs when the motor reaches 2000 operational cycles.

This alarm may be useful for scheduling maintenance operations.

To interrupt the alarm, simply press and hold the START button for 5 seconds, or power off the device for several seconds.

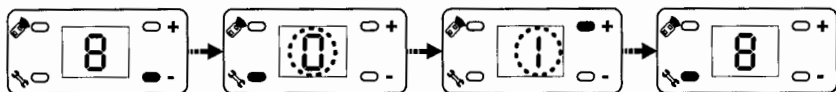

Press the - key,
the display shows 8

Press the key: 0 flashes
to indicate that the function
is deactivated

Press the + key to activate
the function: the display
shows 1

Press the key to save
the settings: the display
shows 8

9. End programming

To exit the programming and store the settings of the different parameters, it is necessary to follow this procedure:

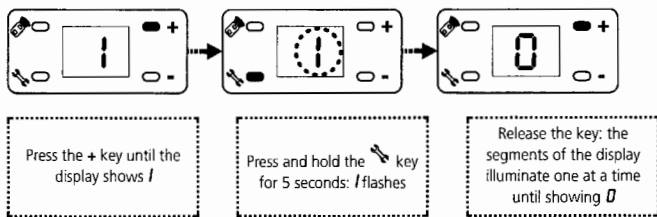

MEMORISING REMOTE CONTROL UNITS

The device can memorise up to 15 remote control units. To memorise a remote control unit, proceed as follows:

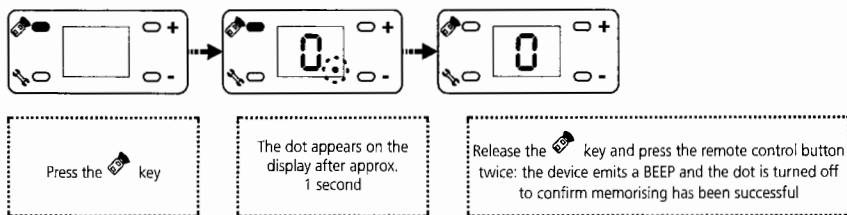

PLEASE NOTE: To select the button to be used to control the automation system, please refer to section "5. Selecting the remote control button"

DELETING REMOTE CONTROL UNITS

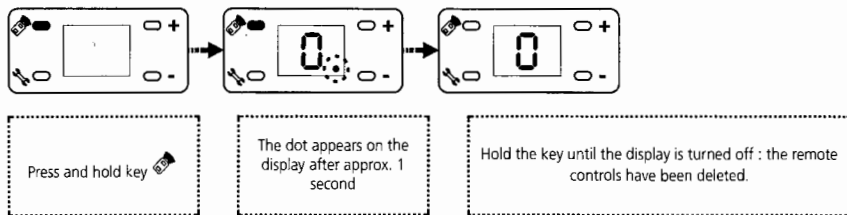

DISPLAY MESSAGES

Display	Reason
L	The display shows the letter L when the actuator is working normally and the red cam positioned on the chain activates the micro switch on the motor
F	The display shows the letter F when the door encounters an obstacle
H	The display shows the letter H when the encoder or the control unit is malfunctioning
A	The display shows the letter A when the photocell intervenes

INDEX

DECLARATION DE CONFORMITÉ	21
DONNEE TECHNIQUES	21
CONSEILS IMPORTANTS	22
OPERATIONS PREALABLES	23
SCHÉMA D'INSTALLATION	23
MONTAGE DU PROFILÉ DE GUIDAGE	24
MONTAGE DU MOTEUR SUR LE PROFILÉ	25
INSTALLATION	25
DEVERROUILLAGE DE L'AUTOMATISATION	26
RACCORDEMENTS ÉLECTRIQUES	26
PROGRAMMATION DES PARAMÈTRES DE FONCTIONNEMENT	27
MÉMORISATION DES TÉLÉCOMMANDES	30
EFFACEMENT DES TÉLÉCOMMANDES	30

DÉCLARATION D'INCORPORATION POUR LES QUASI-MACHINES (Directive 2006/42/CE, Annexe II-B)

Le fabricant (*) **V2 S.p.A.**, ayant son siège social a:
Corso Principi di Piemonte 65, 12035, Racconigi (CN), Italie

Déclare sous sa propre responsabilité que:
 l'automatisme modèle:
AZIMUT (*), AZIMUT-120V (*)

Numéro de fabrication et année de construction: **positionnés sur la plaque de données**
 Description: **actionneur électromécanique pour portes de garage**

- a été conçu pour être incorporé dans une **porte de garage** en vue de former une machine conformément à la Directive 2006/42/CE.
 Cette machine ne pourra pas être mise en service avant d'être déclarée conforme aux dispositions de la directive 2006/42/CE (Annexe II-A)
- est conforme exigences essentielles applicables des Directives:
 Directive Machines 2006/42/CE (Annexe I, Chapitre 1)
 Directive basse tension 2006/95/CE
 Directive compatibilité électromagnétique 2004/108/CE
 Directive Radio 99/05/CE

La documentation technique est à disposition de l'autorité compétente sur demande motivée à l'adresse suivante:
V2 S.p.A., Corso Principi di Piemonte 65, 12035, Racconigi (CN), Italie

La personne autorisée à signer la présente déclaration d'incorporation et à fournir la documentation technique est :

Cosimo De Falco
 Représentant légal de V2 S.p.A.
 Racconigi, le 11/01/2010

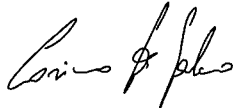

(*) produit fabriqué hors UE pour V2 S.p.A.

DONNEE TECHNIQUES

	AZIMUT	AZIMUT-120V
Alimentation	230Vac - 50Hz	120Vac - 60Hz
Max puissance absorbée	100W	100W
Lampe	230V - 25W	120V - 25W
Fusible de protection	SOURCE = 2,5A LIGHT = 2,5 A	SOURCE = 2,5A LIGHT = 2,5 A
Surface porte	≤ 8m ²	≤ 8m ²
Vitesse moyenne	110mm/s	110mm/s
Force au démarrage	500N	500N
Force nominale	350N	350N
Température de fonctionnement	-20 ÷ +40 °C	-20 ÷ +40 °C
Temps de fonctionnement continu	> 4 min.	> 4 min.
Degré de protection	IP20	IP20
Poids	10Kg	10Kg