

Moon

CE

Control unit MC824H

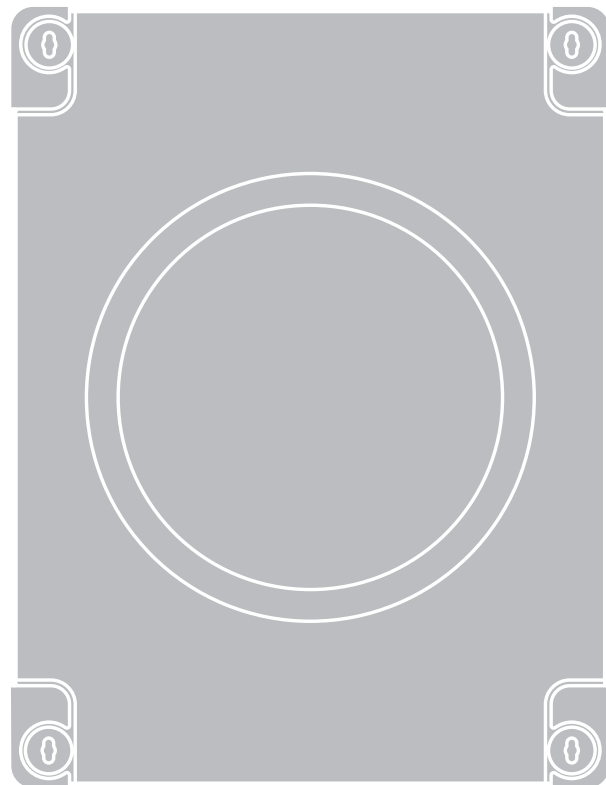

EN - Instructions and warnings for installation and use

IT - Istruzioni ed avvertenze per l'installazione e l'uso

FR - Instructions et avertissements pour l'installation et l'utilisation

ES - Instrucciones y advertencias para la instalación y el uso

DE - Installierungs-und Gebrauchsanleitungen und Hinweise

PL - Instrukcje i ostrzeżenia do instalacji i użytkowania

NL - Aanwijzingen en aanbevelingen voor installatie en gebruik

Nice

Contents

GENERAL SAFETY WARNINGS AND PRECAUTIONS	1
Safety warnings	1
Installation warnings	1
Safety warnings	1
1 - PRODUCT DESCRIPTION AND INTENDED USE	1
2 - INSTALLATION	1
2.1 - Preliminary checks for installation	1
2.2 - Product application limits	2
2.3 - Typical system	2
2.4 - Installation of control unit	2
3 - ELECTRICAL CONNECTIONS	2
3.1 - Description of electrical connections	2
3.2 - Connection of other devices to MC824H	3
3.3 - Connected device address assignment to MC824H	3
3.4 - Initial start-up and electrical connections	3
3.5 - Learning of the devices connected to MC824H	3
3.6 - Selection of type of gearmotor connected to MC824H and learning of the positions of the mechanical stops	3
3.6.1 - Selecting the motor type and learning procedure in automatic mode	3
3.6.2 - Selecting the motor type and learning procedure in manual mode	3
3.7 - Checking movement of gate leaves	4
4 - TESTING AND COMMISSIONING	4
4.1 - Testing	4
4.2 - Commissioning	4
5 - PROGRAMMING	4
5.1 - Level one programming (ON-OFF functions)	5
5.2 - Level two programming (adjustable parameters)	5
5.3 - Special functions	7
5.4 - Deletion of memory	7
6 - WHAT TO DO IF... (troubleshooting guide)	7
7 - FURTHER DETAILS	8
7.1 - Connecting a radio receiver	8
7.2 - Connecting Oview programming unit	9
7.3 - Connecting the Solemyo solar energy system	9
7.4 - Connecting model PS324 buffer battery	9
8 - PRODUCT MAINTENANCE	9
PRODUCT DISPOSAL	9
TECHNICAL CHARACTERISTICS OF THE PRODUCT	10
CE DECLARATION OF CONFORMITY	10
APPENDIX	I
Instructions and warnings for the user	II
Images	IX

Safety warnings

- **IMPORTANT!** – This manual contains important instructions and warnings for personal safety. Incorrect installation could cause serious physical injury. Read all parts of the manual carefully before starting work. If in doubt, interrupt installation and contact the Nice Service Centre for clarifications.
- **IMPORTANT!** – Important instructions: keep this manual in a safe place to enable future product maintenance and disposal procedures.

Installation warnings

- Before commencing installation, check that the product is suitable for the intended kind of use (see paragraph 2.2 “Limits of use” and “Product technical specifications”). If not suitable, do NOT proceed with installation.
- On the power line to the system, install a device for disconnection from the power mains with a gap between contacts that assures complete disconnection in the conditions of overvoltage category III.
- Connect the control unit to an electric power line equipped with an earthing system.
- During installation, handle the product with care, avoiding the risk of crushing, impact, dropping or contact with any type of liquid. Never place the product near sources of heat or expose to naked flames. This may damage product components and cause malfunctions, fire or hazardous situations. If this occurs, suspend installation immediately and contact the Nice Service Centre.
- Never make modifications to any part of the product. Operations other than as specified can only cause malfunctions. The manufacturer declines all liability for damage caused by makeshift modifications to the product.
- The product’s packaging materials must be disposed of in full compliance with local regulations.

Safety warnings

- The product should not be used by children or people with impaired physical, sensorial or mental capacities or who have not received adequate training in the safe use of the product.
- In the vicinity of the automation children must be supervised to ensure that they do not play with it.

1 PRODUCT DESCRIPTION AND INTENDED USE

MC824H is an electronic control unit for the automation of swing gates. **IMPORTANT!** – Any other use than as specified herein or in environmental conditions other than as stated in this manual is to be considered improper and is strictly prohibited!

The control unit is ready for connection to devices belonging to the Opera system, the Bluebus system and the Solemyo solar energy supply system. If powered from the mains, it can house a buffer battery (model PS324, optional accessory), which ensures that the automation can perform a number of manoeuvres for several hours in the event of a power failure. Other available accessories include the dedicated receivers with “SM” fitting (SMXI, OXI, etc.).

2 INSTALLATION

2.1 - Preliminary checks for installation

Before proceeding with installation, check the condition of the product components, suitability of the selected model and conditions of the intended installation environment:

- Ensure that all material used is in perfect condition and suitable for use.
- Ensure that all conditions of use remain within the limits of product application (paragraph 2.2) and within the limit values stated in the “Product technical specifications”.
- Ensure that the selected installation environment is compatible with the overall dimensions of the product (**fig. 1**).
- Ensure that the selected surfaces for product installation are solid and guarantee a stable fixture.
- Make sure that the fixing zone is not subject to flooding. If necessary, mount the product raised from the ground.
- Ensure that the space around the product enables easy and safe access.
- Make sure that all the electrical cables used are of the type listed in **Table 1**.
- Make sure that the automation is provided with mechanical stops on both closing and opening.

2.2 - Product application limits

The product may be used exclusively with gearmotors METRO (model ME3024), MOBY (model MB4024-MB5024), HYPPO (model HY7024-HY7124), TOONA (model TO4024-TO5024-TO7024) and X-metro (model XME2124) in accordance with the corresponding usage limits.

2.3 - Typical system

Fig. 2 shows an example of an automation system set up with Nice components:

- a - Control unit
- b - Gearmotor
- c - Flashing light
- d - Photocell
- e - Digital keyboard - Transponder reader - Key selector
- f - Photocell post
- g - Opening mechanical stops
- h - Closure mechanical stops

These parts are positioned according to a typical standard layout. With reference to fig. 2, locate the approximate position for installation of each component making up the system. **Important** – Before installation, prepare the electrical cables needed for your system, referring to fig. 2 and “Table 1 - Technical characteristics of electrical cables”.

Important – During installation of ducting for electrical cables and the introduction of cables into the control unit enclosure, be aware that due to possible water deposits in the junction boxes, the connecting ducts may form condensation inside the control unit which is liable to damage the electronic circuits.

2.4 - Installation of control unit

To mount the control unit, proceed as shown in fig. 3:

01. Open the control unit box by undoing the relevant screws (fig. 3-A);
02. Prepare the electrical cable routing holes (fig. 3-B);
03. Mount the box (fig. 3-C);
04. The electrical connections can now be made: see chapter 3.

Important! – To prepare the inlets for the electrical cable ducting, holes must be drilled in the lower side of the control unit box. **Note** – *If necessary, the lateral cable inlet may be used, but only with the aid of suitable duct fittings.*

To install the other devices present in the automation, refer to the relevant instruction manuals.

TABLE 1 - Technical specifications of electrical cables

Connection	Cable type	Maximum admissible length
A: CONTROL UNIT POWER cable	1 cable 3 x 1,5 mm ²	30 m (note 1)
B: FLASHING LIGHT with aerial cable	1 cable 2 x 0,5 mm ² 1 shielded cable type RG58	20 m 20 m (less than 5 m recommended)
C: BLUEBUS DEVICES cable	1 cable 2 x 0,5 mm ²	20 m (note 2)
D: KEY-OPERATED SELECTOR SWITCH cable	2 cables 2 x 0,5 mm ² (note 3)	50 m
E: GEARMOTOR POWER cable	1 cable 3 x 1,5 mm ² (note 4)	10 m
F: ENCODER CONNECTION cable	1 cable 2 x 1 mm ² (note 4)	10 m

Note 1 – If the power cable is longer than 30 m, a cable with a larger cross-section is required (3 x 2.5 mm²) and safety earthing is necessary in the vicinity of the automation.

Note 2 – If the Bluebus cable is longer than 20 m (up to max. 40 m), a cable with a larger cross-section is required (2 x 1 mm²).

Note 3 – These 2 cables can be replaced by a single 4 x 0.5 mm² cable.

Note 4 – These 2 cables can be replaced by a single 5 x 1.5 mm² cable.

IMPORTANT! – The cables used must be suited to the installation environment.

3 ELECTRICAL CONNECTIONS

The electrical connection of the various devices (photocells, digital keyboard, transponder card readers, etc.) contained in the automation with the control unit must be made by means of the Nice “Bluebus” system. This system allows electrical connections to be made using just 2 conductors for both the electricity supply and the communication signals. The electrical connection to be used is of the parallel type and no polarity needs to be observed. During the learning stage, the control unit will recognise individually all devices connected to it thanks to a unique code. Each time a device is added or eliminated, it will be necessary to make the control unit perform the learning operation (see paragraph 3.4).

After mounting the control unit box and preparing the electrical cable holes (chapter 2.4 and fig. 3), make the electrical connections:

IMPORTANT!

– All electrical connections must be made with the unit disconnected from the mains power supply and with the buffer battery disconnected, if present in the automation.

– Connections must be made exclusively by qualified personnel.

01. Connect first the electrical power supply cable (fig. 4) and then the electrical cables of motors M1 and M2 (fig. 5).

02. Lastly, connect the electrical cables of the various devices present in the system with reference to the electrical diagram in fig. 6.

Note – To facilitate cable connections, the terminals can be removed from their seats.

3.1 - Description of electrical connections

AERIAL	input for the radio receiver aerial
FLASH	output for 1 flashing light with 12V (maximum 21W) bulb. [*]
ELS	output for 12Vac (maximum 15VA) electric lock. [*]
S.C.A.	“Open Gate Light”: output for 1 indication lamp (24V maximum 4W). [*]
BLUEBUS	input for compatible devices (MOFB, MOFOB, MOB and MOTB); they are connected in parallel using two conductors through which both the electricity supply and the communication signals travel;

no polarity needs to be observed. Each device is individually recognized because a unique address is assigned to it during installation

STOP	input for devices that cause the immediate interruption of the manoeuvre in progress (with a short reverse run); NO and NC contacts, as well as devices with 8.2 kΩ constant resistance output (sensitive edges) can be connected to this input. Each device connected to this input is recognised individually by the control unit during the learning stage (paragraph 3.4); in this stage, if the control unit detects any variations with respect to the learned state, it causes a STOP. One or more devices of the same or different kinds can be connected to this input: – connect a number of NO devices in parallel without quantity limits; – connect a number of NC devices in parallel without quantity limits; – connect 2 devices with 8.2 kΩ constant resistance output in parallel. If there are more than 2 devices, they must be connected in a cascade with just one 8.2 kΩ termination resistance; – connect 2 NO and NC devices in parallel, placing a 8.2 kΩ resistance in series on the NC contact (this also allows for a combination of three devices NO - NC and 8.2 kΩ)
P.P.	input for devices which control Step-by-Step manoeuvres. NO contacts can be connected to this input
OPEN	input for devices which control only opening manoeuvre. NO contacts can be connected to this input
CLOSE	input for devices which control only closure manoeuvre. NO contacts can be connected to this input
ENC1	input encoder – gearmotor 1 (terminal 1, 2); it is not necessary to observe any polarity
ENC2	input encoder – gearmotor 2 (terminal 4, 5); it is not necessary to observe any polarity
M1	output for gearmotor 1 (terminal 7, 8, 9)
M2	output for gearmotor 2 (terminal 10, 11, 12)

[*] The FLASH, ELS and S.C.A. outputs can be programmed with other functions (see “TABLE 5 - 1st level functions”; or via Oview programmer, see chapter 7.2).

IMPORTANT! – If the system has a single gearmotor, it must be connected to terminals of M2 (10, 11, 12).

IMPORTANT! – Connections must be made exclusively by qualified personnel.

3.2 - Connection of other devices to MC824H

If further devices present in the system need to be powered, for example a transponder card reader or the key selector light, these devices can be connected to the control unit using terminals “P.P. (positive)” and “STOP (negative)” (fig. 6). The power supply voltage is 24 Vdc, -30% ÷ +50%, with maximum available current 200 mA.

Note – The voltage present on terminals “P.P.” and “STOP” remains connected even when the “Stand By” function is activated on the card.

3.3 - Connected device address assignment to MC824

To enable the control unit to recognise the devices connected to the Bluebus system, they must be assigned addresses. This operation must be performed by correctly positioning the electric jumper present in every device. Refer to the instruction manual for each individual device.

ATTENZIONE! – When assigning addresses to the photocells, the configuration shown in PHOTO 3 below is not permitted.

PHOTO 3
NON-PERMITTED CONFIGURATION

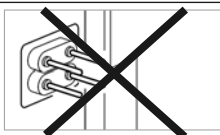

At the end of the installation procedure or following the removal of photocells or other devices, the self-learning procedure for these devices must be performed. See paragraph 3.5.

3.4 - Initial start-up and electrical connections

After powering up the control unit, perform the following checks:

- After a few seconds, make sure that the “Bluebus” LED (fig. 7) flashes regularly with a frequency of about one flash per second.
- Make sure that the LEDs on the photocells (fig. 7) flash (both on TX and RX). The type of flashing is not important during this stage.
- Make sure that the flashing light connected to the FLASH output is off.

If the above conditions are not satisfied, switch off the power supply to the control unit and check the electrical connections previously made.

3.5 - Learning of the devices connected to MC824H

After the initial power-up, the control unit must be able to recognise the devices connected to the “Bluebus” and “Stop” inputs.

IMPORTANT! – The learning procedure must be performed even if no device is connected to the control unit.

The control unit is able to recognise the various connected devices individually through the self-learning procedure and detect possible faults. For this reason it is necessary to perform self-learning every time a new device is added or an existing device is removed.

To indicate when the self-learning procedure is required, LEDs L1 and L2 on the control unit (fig. 7) emit a number of slow flashes:

01. Press and hold down ◀ and “Set” keys at the same time (fig. 7).
02. Release the keys when LEDs L1 and L2 start flashing quickly (after approx. 3 seconds).
03. Wait a few seconds for the control unit to complete the device learning phase.
04. At the end of this phase, the “Stop” LED must be lit and LEDs “L1” and “L2” must be turned off (LEDs L3 and L4 may start flashing).

3.6 - Selection of type of gearmotor connected to MC824H and learning of the positions of the mechanical stops

After learning the devices (paragraph 3.5), the control unit must select the connected motor type (see Table 2) and the positions of the mechanical stops (max. Opening and max. Closing positions). These procedures can be performed in two ways: **automatic** or **manual**.

In automatic mode, the control unit performs learning of the mechanical stops and calculates the most suitable offsets of the leaves (SA and SC in table 3). In manual mode, the positions are programmed one by one by moving the leaves to the desired points. It is also possible to perform an automatic procedure and then adjust one or more positions using the manual procedure if those calculated automatically are not adequate.

TABLE 2

LED	Gearmotor type
L1	MB4024 - MB5024 - HY7024 - HY7124
L2	ME3024
L3	TO4024 - XME2124
L4	TO5024
L5	TO7024

3.6.1 - Selecting the motor type and learning procedure in **automatic** mode:

01. Press and hold down “Set” and ▶ keys at the same time.
02. Release the keys when LED L1 begins to flash (motor selection: **not performed**) or when any of the LEDs L1 ... L8 lights up (motor selection: **already performed**).
03. Press ◀ or ▶ keys within 10 seconds to go to the LED corresponding to the type of gearmotor connected to the control unit (see Table 2);
04. Press and hold down the “Set” key for at least 3 seconds to memorize the selected gearmotor. After 3 sec. LED L1 starts flashing, then release the key;
05. Press and hold down “Set” and ▶ keys at the same time;
06. Release the keys when LEDs L3 and L4 begin to flash quickly (after approx. 3 seconds);
07. Check that the automation performs the following sequences of manoeuvres:
 - a - Slow closure of gearmotor M1 as far as mechanical stop
 - b - Slow closure of gearmotor M2 as far as mechanical stop
 - c - Slow opening of gearmotor M2 and gearmotor M1 as far as mechanical stop
 - d - Complete fast closure of gearmotors M1 and M2

Note – If the first two manoeuvres (a and b) are not “closure” but “opening” manoeuvres, press the “open” or “close” keys to stop the self-learning procedure. Now, on the gearmotor that performed the opening manoeuvre, invert the polarities of the two wires of the gearmotor (M1: terminals 7 and 9 - M2: terminals 10 and 12) and begin the procedure from point 01.
08. At the end of the closure manoeuvre of the 2 motors (d), the LEDs L3 and L4 turn off to indicate that the procedure has been completed correctly.

3.6.2 - Selecting the motor type and learning procedure in **manual** mode:

Using manual learning it is possible to program the automation with all 8 positions and with the sequence described in Table 3.

TABLE 3

Position	LED	Description
Position 0 (motor 1)	L1	Maximum closing position: when leaf 1 reaches closing mechanical stop
Position 0 (motor 2)	L2	Maximum closing position: when leaf 2 reaches closing mechanical stop
Position SA (motor 2)	L3	Opening offset: when leaf 2 passes this position the opening of leaf 1 begins
Position A (motor 1)	L4	Desired opening position: position at which the leaf connected to motor 1 must stop at the end of an opening manoeuvre. This position does not need to coincide with the opening mechanical stop but can be chosen as desired between the positions 0 and 1
Position A (motor 2)	L5	Desired opening position: position at which the leaf connected to motor 2 must stop at the end of an opening manoeuvre. This position does not need to coincide with the opening mechanical stop but can be chosen as desired between the positions 0 and 1
Position SC (motor 1)	L6	Closing offset: when leaf 1 reaches this position, leaf 2 begins to close
Position 1 (motor 1)	L7	Maximum opening position: when leaf 1 reaches the opening mechanical stop
Position 1 (motor 2)	L8	Maximum opening position: when leaf 2 reaches the opening mechanical stop

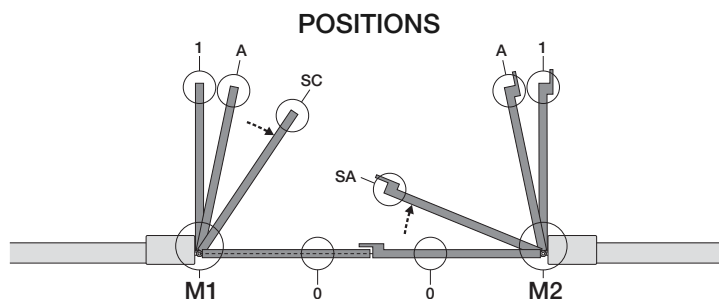

Important – From step 5 onwards, to go from one “position” to a subsequent or previous one, press and then immediately release the key ◀ or ▶ (pressing key ◀ or ▶ quickly moves the LED indicating position, holding the key ◀ or ▶ down moves the motor).

01. Press and hold down “Set” and ▶ keys at the same time;
02. Release the keys when LED L1 begins to flash (motor selection: **not performed**) or when any of the LEDs L1 ... L8 lights up (motor selection: **already performed**);
03. Press ◀ or ▶ keys within 10 seconds to go to the LED corresponding to the type of gearmotor connected to the control unit (see Table 2);
04. Press and hold down the “Set” key for at least 3 seconds to memorize the selected gearmotor. After 3 sec. LED L1 starts flashing, then release the key;

- 05.** • **position 0 of M1** (LED L1 flashes)
To bring motor 1 to **position 0**: press and hold down the ◀ or ▶ keys. On reaching the position, release the key to stop the manoeuvre. To memorise the position, press and hold down the "Set" key for at least 3 seconds and then release it (after 2 seconds LED L1 remains on and on releasing the "Set" key LED L2 begins flashing).
- **position 0 of M2** (LED L2 flashes)
To bring motor 2 to **position 0**: press and hold down the ◀ or ▶ keys. On reaching the position, release the key to stop the manoeuvre. To memorise the position, press and hold down the "Set" key for at least 3 seconds and then release it (after 2 seconds LED L2 remains on and on releasing the "Set" key LED L3 begins flashing).
- **position SA of M2** (LED L3 flashes)
To bring motor 2 to **position SA**: press and hold down the ◀ or ▶ keys. On reaching the position, release the key to stop the manoeuvre. To memorise the position, press and hold down the "Set" key for at least 3 seconds and then release it (after 2 seconds LED L3 remains on and on releasing the "Set" key LED L4 begins flashing).
- **position A of M1** (LED L4 flashes)
To bring motor 1 to **position A**: press and hold down the ◀ or ▶ keys. On reaching the position, release the key to stop the manoeuvre. To memorise the position, press and hold down the "Set" key for at least 3 seconds and then release it (after 2 seconds LED L4 remains on and on releasing the "Set" key LED L5 begins flashing).
- **position A of M2** (LED L5 flashes)
To bring motor 2 to **position A**: press and hold down the ◀ or ▶ keys. On reaching the position, release the key to stop the manoeuvre. To memorise the position, press and hold down the "Set" key for at least 3 seconds and then release it (after 2 seconds LED L5 remains on and on releasing the "Set" key LED L6 begins flashing).
- **position SC of M1** (LED L6 flashes)
To bring motor 1 to **position SA**: press and hold down the ◀ or ▶ keys. On reaching the position, release the key to stop the manoeuvre. To memorise the position, press and hold down the "Set" key for at least 3 seconds and then release it (after 2 seconds LED L6 remains on and on releasing the "Set" key LED L7 begins flashing).
- **position 1 of M1** (LED L7 flashes)
To bring motor 1 to **position 1**: press and hold down the ◀ or ▶ keys. On reaching the position, release the key to stop the manoeuvre. To memorise the position, press and hold down the "Set" key for at least 3 seconds and then release it (after 2 seconds LED L7 remains on and on releasing the "Set" key LED L8 begins flashing).
- **position 1 of M2** (LED L8 flashes)
To bring motor 2 to **position 1**: press and hold down the ◀ or ▶ keys. On reaching the position, release the key to stop the manoeuvre. To memorise the position, press and hold down the "Set" key for at least 3 seconds and then release it to exit programming (after 2 seconds LED L8 remains on until the "Set" key is released).

Manual learning of all the positions can be performed at any time, even after performing installation. The procedure must commence from point 01. However, it is not necessary to reprogram all the positions: from step 5 onwards, by quickly pressing key ◀ or ▶ it is possible to move the LED to the desired position to be programmed. To end manual learning, press key ▶ repeatedly until the flashing LED goes beyond L8.

3.7 - Checking movement of gate leaves

At the end of the learning procedure, it is advisable to make the control unit perform a few opening and closing manoeuvres to ensure that the gate moves correctly and to check for installation or setting defects.

- 01.** Press the "Open" key. Check for the correct leaf opening offset and check that the opening manoeuvre includes the acceleration, constant speed and deceleration phases and that the leaf limit switch is set a few centimetres from the opening mechanical stops.
- 02.** Press the "Close" key and check that the closure manoeuvre includes the acceleration, constant speed and deceleration phases. Check that the leaf closure offset is correct. At the end of the manoeuvre, the leaves must be perfectly closed on the mechanical closure stop.
- 03.** Make sure that the flashing light flashes at intervals of 0.5 sec on, 0.5 sec off during manoeuvres.

4 TESTING AND COMMISSIONING

These are the most important phases of automation set-up for ensuring maximum system safety. The test can also be performed as a periodic check of automation devices. Testing and commissioning of the automation must be performed by skilled and qualified personnel, who are responsible for the tests required to verify the solutions adopted according to the risks present, and for ensuring observance of all legal provisions, standards and regulations, and in particular all requirements of the standard EN 12445, which establishes the test methods for checking automations for doors and gates. The additional devices must undergo a specific test for functionality and correct interaction with MC824H. Refer to the instruction manuals of the individual devices.

4.1 - Testing

The sequence of operations to be performed for testing and described below refers to a typical system (fig. 2):

- 1** Ensure that everything stated in the "Installation warnings" chapter has been observed.
- 2** Release the gearmotors for manual operation as described in the relevant instruction manual. Pushing at the prescribed point for manual operation, check that it is possible to open and close the leaves with a force lower than 390 N.
- 3** Lock the gearmotors (see relevant instruction manual).
- 4** Using the control devices (transmitter, key-operated selector switch or control pushbuttons, etc.), perform tests of opening, closing and stopping the gate, and ensure that leaf movement corresponds to specifications. Test several times to check for leaf movement and any defects in assembly or adjustment and any possible points of friction.
- 5** Check operation of all system safety devices one at a time (photocells, sensitive edges, etc.). Each time a device is activated the "BLUEBUS" LED on the control unit must flash rapidly twice to confirm acknowledgement of the event.
- 6** If hazardous situations generated by the moving leaves are protected by means of impact force limitation, measure the force as specified in the standard EN 12445. If gearmotor force control is used as auxiliary function with the system for reduction of impact force, test and identify the setting that obtains the best results.

4.2 - Commissioning

Commissioning can only be performed after positive results of all test phases.

- 1** Prepare the automation technical documentation, which must contain the following documents: overall drawing of the automation, electrical wiring diagram, risk assessment and solutions adopted, manufacturer's declaration of conformity for all devices used and installer's declaration of conformity.
- 2** Apporre sul cancello una targhetta contenente almeno i seguenti dati: tipo di automazione, nome e indirizzo del costruttore (responsabile della "messa in servizio"), numero di matricola, anno di costruzione e marchio "CE".
- 3** Affix a dataplate on the door, specifying at least the following data: type of automation, name and address of manufacturer (responsible for commissioning), serial number, year of construction and CE mark.
- 4** Compile the "Operation manual" for the automation and forward it to the owner.
- 5** Compile the form "Maintenance schedule" containing all maintenance instructions for all devices in the automation and forward it to the owner.
- 6** Before commissioning the automation, ensure that the owner is adequately informed of all associated risks and hazards.

For all the above-mentioned documentation, Nice provides instruction manuals, guides and pre-filled forms through its technical support service. Also see: www.nice-service.com

5 PROGRAMMING

The control unit has 3 keys **OPEN** (◀), **STOP (SET)**, **CLOSE** (▶) that can be used both for controlling the unit during testing and for programming the available functions.

The programmable functions available are divided into 2 levels and their relative operating status is displayed by means of the 8 LEDs (L1...L8) on the control unit (LED lit = function active; LED off = function not active).

Use the programming keys:

OPEN (◀): – key for controlling gate opening; – selection key during programming.

STOP/SET: key for stopping a manoeuvre; if pressed for more than 5 seconds, it enables entry to programming mode.

CLOSE (▶): – key for controlling gate closure; – selection key during programming.





5.1 - Level one programming (ON-OFF functions)

All level 1 functions are set by default to **“OFF”** and may be modified at any time. To check the functions see **Table 5**. For the programming procedure see **Table 6**.

IMPORTANT – In the programming procedure, the maximum time interval that can elapse between activation of one key and the next is 10 seconds. When this time elapses, the procedure terminates automatically, memorising the modifications made up until then.

LED	Function	Description
L1	Automatic closure	Function ACTIVE: after an opening movement, there is a pause (equal to the programmed time) after which the control unit automatic initiates a closure movement. The factory setting for the Pause time is 30 sec. Function NOT ACTIVE: function is “semiautomatic” type.
L2	Reclose after photo	Function ACTIVE: if the photocells are activated during the opening or closing manoeuvre, the pause time is reduced to 5 seconds regardless of the programmed pause time. With “automatic closure” disabled, if the photocells are activated during closure the “automatic closure” is activated with the programmed “pause time”.
L3	Always close	Function ACTIVE: in the event of a power failure, even of short duration, when power is restored the control unit detects gate open and automatically starts a closure manoeuvre, preceded by 5 seconds of pre-flashing. Function NOT ACTIVE: when power is restored the gate remains where it is
L4	Stand by (Bluebus)	Function ACTIVE: 1 minute after the end of the manoeuvre, the control unit turns off the “Bluebus” output (connected devices) and all the LEDs apart from the Bluebus LED which will flash more slowly. When the control unit receives a command normal operation is restored (with a short delay). This function has the purpose of reducing consumption, an important aspect with battery or photovoltaic panel power supply.
L5	Electric lock/Courtesy light	Function ACTIVE: the “electric lock” output switches its operation to “courtesy light”. Function NOT ACTIVE: the output operates as an electric lock.
L6	Pre-flash	Function ACTIVE: a 3 second pause can be added between the flashing light signal and the start of the manoeuvre to provide advance warning of a hazard situation. Function NOT ACTIVE: flashing light signal coincides with the start of the manoeuvre.
L7	“Close” becomes “Partial open 1”	Function ACTIVE: all the commands corresponding to “Close” (“Close” input or “Close” radio control) are replaced by the “Partial open 1” command.
L8	“Gate open light” or “Maintenance light”	Function ACTIVE: the “gate open light” output on the control unit switches to the “maintenance light” function. Function NOT ACTIVE: the output operates as “gate open light”

TABLE 6 – Programming procedure (first level functions)

01. Press and hold down the “Set” key for approx. 3 seconds;	
02. Release the key when LED “L1” starts flashing;	
03. Press the “◀” or “▶” key to move the flashing LED to the LED representing the function to be modified;	
04. Press “Set” to change the status of the function: (short flash = OFF; long flash = ON);	
05. Wait 10 seconds (maximum time) to exit the programming mode.	





Note – During this procedure, points 03 and 04 need to be repeated when programming other functions to **“ON”** or **“OFF”** during the phase itself.

5.2 - Level two programming (adjustable parameters)

All level 2 functions are set by default as highlighted in **grey** in **Table 8**, and may be modified at any time as explained in **Table 7**. The parameters can be set on a scale from 1 to 8. To check the value corre-

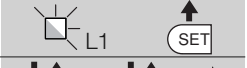
sponding to each LED see **Table 8**. **IMPORTANT** – In the programming procedure, the maximum time interval that can elapse between activation of one key and the next is 10 seconds. When this time elapses, the procedure terminates automatically, memorising the modifications made up until then.

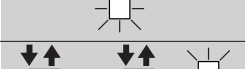
TABLE 7 – Programming procedure (second level functions)

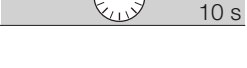
01. Press and hold down the “Set” key for approx. 3 seconds.;	
02. Release the key when LED “L1” starts flashing;	
03. Press the “◀” or “▶” key to move the flashing LED to the LED representing the “input LED” of the parameter to be modified;	
04. Press and hold the “Set” key through to completion of point 06;	
05. Wait approx. 3 seconds, until the LED representing the current level of the parameter to be modified illuminates;	
06. Press keys “◀” or “▶” to move the LED representing the value of the parameter;	
07. Release the “Set” key;	
08. Wait 10 seconds (maximum time) to exit the programming mode.	

Note – During this procedure, points 03 to 07 need to be repeated when programming other parameters during the phase itself.

TABLE 8 - Second level functions

Input LED	Parameter	LED (level)	Value	Description
L1	Pause time	L1	5 seconds	Sets the pause time, namely the time which lapses before automatic closure. This will only take effect if closing is active.
		L2	15 seconds	
		L3	30 seconds	
		L4	45 seconds	
		L5	60 seconds	
		L6	80 seconds	
		L7	120 seconds	
		L8	180 seconds	
L2	Step by step function	L1	Open – stop – close – stop	Sets the sequence of commands associated with the “Step-by-Step”, “Open”, or “Close” inputs or the radio control. <i>Note – When setting L4, L5, L7 and L8, the behaviour of the “Open” and “Close” commands is also modified.</i>
		L2	Open – stop – close – open	
		L3	Open – close – open – close	
		L4	Apartment block: • In the opening manoeuvre the “Step by Step” and “Open” commands have no effect; the “Close” command causes the movement to be inverted, i.e. the closure of the leaf. • In the closure manoeuvre the “Step by Step” and “Open” commands cause the movement to be inverted, i.e. the leaf to open; the “Close” command has no effect.	
		L5	Apartment block 2: • In the opening manoeuvre the “Step by Step” and “Open” commands have no effect; the “Close” command causes the movement to be inverted, i.e. the closure of the leaf. If the transmitted command persists for more than 2 seconds, a “Stop” is performed. • In the closure manoeuvre the “Step by Step” and “Open” commands cause the movement to be inverted, i.e. the leaf to open; the “Close” command has no effect. If the transmitted command persists for more than 2 seconds, a “Stop” is performed.	
		L6	Step-by-step 2 (less than 2 sec. generates partial opening).	
		L7	Hold-to-run: the manoeuvre is performed only if the transmitted command persists; if the command is interrupted the manoeuvre stops.	
		L8	Opening in semi-automatic mode, closing in hold-to-run mode.	
L3	Motor speed	L1	Very slow	Sets the motor speed during normal travel.
		L2	Slow	
		L3	Medium	
		L4	Fast	
		L5	Very fast	
		L6	Extremely fast	
		L7	Fast opening, Slow Closing	
		L8	Extremely fast Opening , Medium Closing	
L4	Motor discharge after closing	L1	0 - No discharge	Sets duration of “short inversion” of both motors after performing Close manoeuvre with the aim of reducing the final residual thrust.
		L2	Level 1 – Minimum discharge (about 100 ms)	
		L3	Level ...	
		L4	Level ...	
		L5	Level ...	
		L6	Level ...	
		L7	Level ...	
		L8	Level 7 – Maximum discharge (about 800 ms)	
L5	Motor force	L1	Level 1 – Minimum Force	Adjusts the force of both motors
		L2	Level ...	
		L3	Level ...	
		L4	Level ...	
		L5	Level ...	
		L6	Level ...	
		L7	Level ...	
		L8	Level 8 – Maximum Force	
L6	Pedestrian or partial opening	L1	Pedestrian 1 (opening of leaf M2 to 1/4 of total opening)	Sets type of opening associated with “Partial open 1” command. In levels L5, L6, L7, L8; “minimum” opening means the smaller opening out of M1 and M2; for example, if M1 opens to 90° and M2 opens to 110°, the minimum opening is 90°
		L2	Pedestrian 1 (opening of leaf M2 to 1/2 of total opening)	
		L3	Pedestrian 3 (opening of leaf M2 to 3/4 of total opening)	
		L4	Pedestrian 4 (Complete opening of leaf 2)	
		L5	Partial 1 (opening of two leaves to 1/4 of “minimum” opening)	
		L6	Partial 2 (opening of two leaves to 1/2 of “minimum” opening)	
		L7	Partial 3 (opening of two leaves to 3/4 of “minimum” opening)	
		L8	Partial 4 (opening of two leaves to “minimum” opening)	
L7	Maintenance warning	L1	500	Controls the number of manoeuvres: when this number is exceeded, the control unit signals an automation maintenance request; see paragraph 5.3.2. – Maintenance warning.
		L2	1000	
		L3	1500	
		L4	2500	
		L5	5000	
		L6	10000	
		L7	15000	
		L8	20000	

L8	List of faults	L1	Manoeuvre 1 result (most recent)	The type of fault that has occurred in the last 8 manoeuvres can be established See TABLE 12 – Fault log.
		L2	Manoeuvre 2 result	
		L3	Manoeuvre 3 result	
		L4	Manoeuvre 4 result	
		L5	Manoeuvre 5 result	
		L6	Manoeuvre 6 result	
		L7	Manoeuvre 7 result	
		L8	Manoeuvre 8 result	

Note – The factory settings are highlighted in grey.

5.3 - Special functions

5.3.1 - Function: “Move anyway”

This function allows the automation to be operated even when any of the safety devices does not work correctly or is out of use. The automation can be controlled in the “hold-to-run” mode. Proceed as follows:

- 01.** Send a command to operate the gate using a transmitter or a key selector, etc. If everything operates correctly, the gate will move normally, otherwise proceed as follows;
- 02.** within 3 seconds, activate the control again and keep it activated;
- 03.** after approximately 2 seconds, the gate will perform the required movement in “hold-to-run” mode; i.e. the gate will continue to move only as long as the control is activated.

If the safety devices do not operate, the flashing light flashes a few times to indicate the kind of problem (see chapter 6 - Table 10).

5.3.2 - Function: “Maintenance warning”

This function serves to indicate when the automation requires maintenance. The maintenance warning signal is given by way of a lamp connected to the S.C.A. (open gate light) output when this output is programmed as “Maintenance light”. The various warning lamp signals are shown in Table 9.

To program the limit value of the maintenance operations, see Table 8.

Table 9 - “Maintenance light”

Number of manoeuvres	Signal
Below 80% of the limit	Light on for 2 seconds at the start of the opening manoeuvre.
Between 81% and 100% of the limit	Light flashing for the entire duration of the manoeuvre.
Beyond 100% of the limit	Light flashing continuously.

5.4 - Deleting the memory

To delete the control unit memory and restore all factory settings, proceed as follows:

press and hold keys “◀” and “▶” until leds L1 and L2 start flashing.

6 WHAT TO DO IF... (troubleshooting guide)

Some devices are able to emit signals that serve to recognise their state of operation or possible faults. If a flashing light is connected to the FLASH output on the control unit, it will

flash at intervals of 1 second during a manoeuvre. If faults occur, the flashing light will emit a sequence of two shorter flashes separated by a 1 second pause. Table 10 shows the cause and solution for each type of signal.

The LEDs on the control unit also emit signals.

Table 11 shows the cause and solution for each type of signal.

It is possible to verify faults that have occurred during the last 8 manoeuvres. See Table 12.

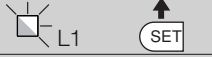

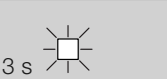

TABLE 10 - Flashing light signals (FLASH)

Flashes	Problem	Solution
1 short flash 1 second pause 1 short flash	Bluebus system error	At the start of the manoeuvre, the devices connected to Bluebus do not correspond to those recognized during the self-learning phase. One or more devices may be disconnected or faulty; check and, if necessary, replace them. In case of modifications repeat the device self-learning process (see paragraph 3.4).
2 short flashes 1 second pause 2 short flashes	Photocell activated	One or more photocells do not enable movement or have caused a movement inversion during travel; check to see if there are any obstructions.
3 short flashes 1 second pause 3 short flashes	Function activation “Obstacle detection” by force limiter	During the movement, the motors encountered excessive resistance; identify the cause and if necessary increase the level of force of the motors.
4 short flashes 1 second pause 4 short flashes	STOP input activation	At the start of the manoeuvre or during the movement, the STOP input was activated; identify the cause.
5 short flashes 1 second pause 5 short flashes	Error on internal parameters in control unit	Wait at least 30 seconds, then try giving a command and if necessary turn off the power supply. If the condition persists, there may be a malfunction and the electronic board must be replaced.
6 short flashes 1 second pause 6 short flashes	Maximum limit of consecutive manoeuvres or manoeuvres per hour exceeded.	Wait a few minutes until the manoeuvre limiting device falls to below the maximum limit.
7 short flashes 1 second pause 7 short flashes	Electric circuits fault	Wait at least 30 seconds, then try sending a command and if necessary turn off the power supply. If the condition persists, there may be a malfunction and the electronic board must be replaced.
8 short flashes 1 second pause 8 short flashes	A command is already present that disables execution of other commands	Check the type of command that is always present; for example, it could be a command from a timer on the “open” input.
9 short flashes 1 second pause 9 short flashes	The automation has been blocked by a “Block automation” command	Release the automation by giving the “Automation release” command.
10 short flashes 1 second pause 10 short flashes	“Obstacle detection” by encoder function activated	During the movement, the motors have been blocked by higher friction; identify the cause.

TABLE 11 - Signals given by LEDs on control unit (fig. 7)

LED	Problem	Solution
BLUEBUS Always off	Fault	Check that the control unit is powered. Check that the fuses have not blown: if they have, check the cause of the fault and replace with others with the same value
Always on	Serious fault	A serious fault has occurred: try disconnecting electrical power from the control unit. If the problem persists it will be necessary to replace the electronic board
1 flash per second	Everything normal	Control unit works correctly
2 quick flashes	Input status variation	Normal if one of the inputs (PP, STOP, OPEN, CLOSE) changes: photocells activated or a command given via a transmitter
Series of flashes separated by one second pause	Various	Refer to Table 10
STOP Always off	Activation of the devices connected to the STOP input	Check the devices connected to the STOP input
Always on	Everything normal	STOP input active
S.S. Always off	Everything normal	S.S. input not active
Always on	S.S. input activation	Normal if the device connected to the S.S. input is active
OPEN Always off	Everything normal	OPEN input not active
Always on	OPEN input activation	Normal if the device connected to the OPEN input is active
CLOSE Always off	Everything normal	CLOSE input not active
Always on	CLOSE input activation	Normal if the device connected to the CLOSE input is active
L1 - L2 Slow flashing	Change in number of devices connected to Bluebus or device self-learning not performed	The device self-learning process must be performed (see paragraph 3.5)
L3 - L4 Slow flashing	Change in self-learning of the motor types or the positions of the mechanical stops	Self-learning of the mechanical stop positions has not been performed

TABLE 12 - Fault log

01. Press and hold down the "Set" key for approx. 3 seconds;	
02. Release the key when LED "L1" starts flashing;	
03. Press keys "◀" or "▶" to move from the flashing LED to L8 LED ("input LED") for the "Fault log" parameter;	
04. Press and hold the "Set" key through to completion of point 06;	
05. Wait approx. 3 seconds until the LEDs representing the levels corresponding to the manoeuvres with faults illuminate. The LED L1 indicates the result of the most recent manoeuvre while L8 indicates the eighth-to-last manoeuvre. If the LED is on this means that a fault has occurred; if the LED is off, everything is normal;	
06. Press keys "◀" and "▶" to select the required manoeuvre: the corresponding LED performs a number of flashes equal to those normally performed by the flashing light;	
07. Release the "Set" key.	

7 FURTHER DETAILS

The following optional accessories are available for the control unit MC824H: SMXI, OXI family receivers, Oview programmer, the Solemyo solar energy panel and the PS324 buffer battery.

7.1 - Connecting a radio receiver

The control unit has a connector for connecting radio receivers (optional accessories) belonging to the SMXI and OXI families. To connect a receiver, disconnect power from the control unit and proceed as shown in **fig. 8**. **Table 13** and **Table 14** show the commands corresponding to the outputs on the control unit.

Table 13**SMXI / SMXIS or OXI / OXIFM / OXIT / OXITFM in mode I or Mode II**

Output no. 1	"S.S." (Step by Step) command
Output no. 2	"Partial opening 1" command
Output no. 3	"Open" command
Output no. 4	"Close" command

Table 14**OXI / OXIFM / OXIT / OXITFM in extended mode II**

No.	Command	Description
1	Step by step	"S.S." (Step by Step) command
2	Partial opening 1	"Partial opening 1" command
3	Open	"Open" command
4	Close	"Close" command
5	Stop	Stops manoeuvre
6	Apartment block Step by Step	Apartment block control
7	Step by Step high priority	Gives command even when automation is blocked or commands are in progress
8	Partial open 2	Partial open (Opening of leaf M2 to 1/2 of normal opening)
9	Partial open 3	Partial open (Opening of two leaves to 1/2 of normal opening)
10	Open and block automation	It causes an opening manoeuvre, after which the automation is blocked; the control unit accepts no further commands with the exception of "Step by step high priority", "Release" automation and (from Oview only) the commands "Release and close" and "Release and open"

No.	Command	Description
11	Close and block automation	It causes a closure manoeuvre, after which the automation is blocked; the control unit accepts no further commands with the exception of "Step by step high priority", "Release" automation and (from Oview only) the commands "Release and close" and "Release and open"
12	Block automation	It causes the manoeuvre to stop and the automation to block; the control unit accepts no further commands with the exception of "Step by step high priority", "Release" automation and (from Oview only) the commands "Release and close" and "Release and open".
13	Release automation	It causes the automation to be released and normal operation to resume
14	Courtesy light timer on	The Courtesy light comes on with timed turning off
15	Courtesy light on-off	The Courtesy light turns on and off in step-by-step mode

7.2 - Connecting Oview programming unit

Connector BusT4 on the control unit enables connection of the programming unit Oview which enables complete and rapid management of installation, maintenance and troubleshooting of any malfunctions of the whole automation system. To gain access to the connector, proceed as shown in **fig. 9** and connect the connector to its seat. The Oview can be connected simultaneously to a number of control units (up to 5 without any particular precautions, up to 60

following the relevant warnings) and can remain connected to the control unit during normal operation of the automation. In this case a specific "user" menu enables commands to be sent directly to the control unit. It is also possible to update the firmware. If an OXI family radio receiver is present in the control unit, Oview enables access to the parameters of the transmitters memorised in this receiver.

Further information is available in the instruction manual and the "Opera system book" manual.

7.3 - Connecting the Solemyo solar energy system

To connect the solar energy system see **fig. 10**.

IMPORTANT! – When the automation is powered by the "Solemyo" system, it MUST NOT BE POWERED at the same time from the electrical mains.

For other information, refer to the relevant instruction manual.

7.4 - Connecting model PS324 buffer battery

To connect the buffer battery, see **fig. 10**. For other information, refer to the relevant instruction manual.

8 PRODUCT MAINTENANCE

Regular maintenance is needed to keep the level of safety constant and to ensure the maximum durability of the entire automation.

Maintenance must be performed in strict accordance with the safety provisions set out in this manual and with the requirements of applicable laws and standards.

Important – During maintenance and cleaning the control unit must be disconnected from the electrical power supply.

For devices other than the MC824H follow the instructions given in the relevant maintenance programmes.

For the MC824H scheduled maintenance must be performed no more than 6 months or 20,000 manoeuvres after previous maintenance.

To perform maintenance, proceed as follows:

- 01.** Disconnect all electric power sources, including any buffer batteries;
- 02.** Check all materials making up the control unit for wear, with particular attention to erosion or oxidation of parts; replace parts that are not in optimal condition;
- 03.** Reconnect the power supply and perform the checks described in chapter 4.1 - Testing.

PRODUCT DISPOSAL

This product is an integral part of the automation system it controls and must be disposed of along with it.

As in the case of installation, likewise at the end of product lifetime the disassembly and scrapping operations must be performed by qualified personnel.

This product is made of various types of material, some of which can be recycled while others must be scrapped. Seek information on the recycling and disposal methods envisaged by the local regulations in your area for this product category.

Important! – Some parts of the product may contain polluting or hazardous substances which, if released to the environment, may cause serious damage to the environment or to human health.

As indicated by the symbol alongside, disposal of this product with domestic waste is strictly prohibited. Separate the waste into categories for disposal, according to the methods established by current legislation in your area, or return the product to the retailer when purchasing a new version.



Important! – Local legislation may impose heavy fines in the event of illegal disposal of this product.

Disposal of buffer battery (if present)

Important! – Even if discharged, the batteries may contain pollutant substances and therefore must NEVER be disposed of in normal waste collection points.

Dispose of according to separate waste collection methods as envisaged by current local standards.

TECHNICAL CHARACTERISTICS OF THE PRODUCT

WARNINGS: • All technical characteristics stated refer to an ambient temperature of 20°C (±5°C). • Nice S.p.a reserves the right to modify the product at any time while maintaining the same functionalities and intended use.

MC824H power supply MC824H/V1 power supply	230 Vac (+10% -15%) 50/60 Hz 120 Vac (+10% -15%) 50/60 Hz
Nominal power absorbed from mains	200 W
Power absorbed from mains in "standby - All" operation (including a receiver)	2 W
Power absorbed by control unit battery connector with "standby-All" operation (including a receiver with SM type connector)	below 100 mW
Flashing light output [*]	1 "LUCYB" type flashing light (12 V, 21 W lamp)
Electric lock output [*]	1 max. 12 Vac max. 15 VA electric lock
Gate open light output [*]	one 24 V max. 4 W lamp (output voltage may vary between -30% and +50%, output may also control small relays)
BLUEBUS output	1 output with maximum load 15 Bluebus units (maximum 6 pairs of MOFB or MOFOB photocells + 2 pairs of MOFB or MOFOB photocells assigned as Opening devices + max. 4 MOMB or MOTB control devices)
STOP Input	For normally closed, normally open or 8.2 kΩ constant resistance contacts in self-learning mode (a change from the memorised state prompts the "STOP" command)
PP Input	for normally open contacts (closure of the contact prompts the Step by Step command)
OPEN Input	for normally open contacts (closure of the contact prompts the OPEN command)
CLOSE Input	for normally open contacts (closure of the contact prompts the CLOSE command)
Radio connector	SM connector for SMXI, OXI and OXIFM family receivers
Radio AERIAL input	50 Ω for RG58 or similar type cable
Programmable functions	8 ON-OFF type functions and 8 adjustable functions
Functions in self-learning mode	<ul style="list-style-type: none"> • Self-learning of devices connected to the BlueBus output • Self-learning of type of device connected to "STOP" terminal (NO, NC or 8.2 kΩ resistance contact) • Self-learning of leaf travel and automatic calculation of deceleration and partial opening points (vary according to installation)
Operating temperature	from - 20 °C a + 50 °C
Use in particularly acid, saline or potentially explosive atmospheres	NO
Protection rating	IP 54 with enclosure intact
Dimensions (mm)	310 x 232 x H 122
Weight (kg)	4,1

[*] The Flashing Light, Electric Lock and Gate Open Warning light outputs can be programmed with other functions (see "TABLE 5 - 1st level functions"; or via Oview programmer, see chapter 7.2). The electrical characteristics of the output vary according to programming:

flashing light: 12Vdc, 21 Wmax lamp

electric lock: 12Vac 15 Vmax

other outputs (all types): 1 lamp or relay 24Vdc (-30 and +50%), 4 Wmax

CE DECLARATION OF CONFORMITY

Note - The contents of this declaration correspond to declarations in the last revision of the official document deposited at the registered offices of Nice Spa available before this manual was printed. The text herein has been re-edited for editorial purposes.

Number: 298/MC824H

Revision: 1

The undersigned, Luigi Paro, in the role of Managing Director, declares under his sole responsibility, that the product:

Manufacturer's Name: NICE s.p.a.
Address: Via Pezza Alta 13, Z.I. Rustigné, 31046 Oderzo (TV) Italy
Type: two 24 Vdc motor control unit
Models: MC824H
Accessories: Radio receiver SMXI, OXI, OXIFM, PS 324, SYKCE, OVIEW unit

Conform with the requirements of the following EC directives:

- 98/37/EC (89/392/EEC amended); DIRECTIVE 98/37/EC OF THE EUROPEAN PARLIAMENT AND COUNCIL of 22 June 1998 regarding the approximation of member state legislation relating to machinery.
As established in directive 98/37/EC, the above-mentioned product may not be started up unless the machine in which the product is incorporated has been identified and declared as conforming to directive 98/37/EC.

The product also complies with the requirements of the following EC directives:

- 2006/95/EEC (ex directive 73/23/EEC); DIRECTIVE 2006/95/EEC OF THE EUROPEAN PARLIAMENT AND COUNCIL of 12 December 2006 regarding the approximation of member state legislation relating to electrical material intended for use within specific voltage limits
According to the following harmonised standards: EN 60335-1:1994+A11:1995+A11:1996+A12:1996+A13:1998+A14:1998+A15:2000+A2:2000+A16:2001
- 2004/108/EEC (ex directive 89/336/EEC); DIRECTIVE 2004/108/EEC OF THE EUROPEAN PARLIAMENT AND COUNCIL of 15 December 2004 regarding the approximation of member state legislation relating to electromagnetic compatibility, repealing directive 89/336/EEC
According to the following harmonised standards: EN 61000-6-2:2005; EN 61000-6-3:2007.

The product also complies, within the constraints of applicable parts, with the following standards: EN 60335-1:2002+A1:2004+A11:2004+A12:2006+ A2:2006, EN 60335-2-103:2003, EN 13241-1:2003; EN 12453:2002; EN 12445:2002; EN 12978:2003

Oderzo, 11 June 2009

Luigi Paro (Managing Director)



EN Appendix

- *Instructions and warnings for the user*
- *Images*

IT Appendice

- *Istruzioni ed avvertenze destinate all'utilizzatore*
- *Immagini*

FR Appendice

- *Instructions et recommandations destinées à l'utilisateur*
- *Images*

ES Apéndice

- *Instrucciones y advertencias destinadas al usuario*
- *Imágenes*

DE Anhang

- *Anweisungen und Hinweise für den Benutzer*
- *Bilder*

PL Załącznik

- *Instrukcje i zalecenia przeznaczone dla użytkownika*
- *Zdjęcia*

NL Bijlage

- *Aanwijzingen en aanbevelingen voor de gebruiker*
- *Afbeeldingen*

Instructions and warnings for the user

Before using the automation for the first time, ask the installer to explain the origin of residual risks and devote a few minutes to reading this user instruction and warning manual given to you by the installer. Keep the manual for reference when in doubt and pass it on to new owners of the automation.

IMPORTANT! – Your automation is a machine that performs your commands faithfully; negligent or improper use may constitute a hazard.

– Never activate automation controls if persons, animals or objects are present in the operating range.

– NEVER touch parts of the automation while the gate or door is moving!

– Photocells are not safety devices but safety aids. They are constructed with very reliable technology but in extreme situations they may malfunction or even break. In some cases this malfunction may not be immediately evident. For this reason, observe the following warnings when using the automation:

- Pass through the gate or door only when it is completely open and the leafs have stopped moving.

- NEVER pass through while the gate or door is closing!

- Periodically check correct operation of the photocells.

• **Children:** an automation system guarantees a high level of safety, using a special detection system to prevent movement in the presence of persons or objects. Nonetheless, it is advisable to ensure that children do not play in the vicinity of the automation. To prevent the risk of accidental activation, do not leave the remote controls within the reach of children **It is not a game!**

• The product should not be used by children or people with impaired physical, sensorial or mental capacities or who have not received adequate training in the safe use of the product.

• **Malfunctions:** if the automation is seen to perform abnormally, disconnect the electrical power supply from the system and manually release the gearmotor (see instruction manual) to operate the gate manually. Never attempt to perform repairs; contact your local installer for assistance.

• **Never modify the system or the control unit programming and adjustment parameters: this is the responsibility of the installer.**

• **Power supply failure or absence:** while waiting for the installer or the electrical power supply to return, the automation can still be used even if the system is not equipped with a buffer battery: manually release the gearmotor (see instruction manual) and move the gate leaf manually as required.

• **Safety devices disabled:** the automation can be operated even when a safety device does not work correctly or is out of use. The gate can be controlled in the “hold-to-run” mode. Proceed as follows:

01. Send a command to operate the gate using a transmitter or a key selector, etc. If everything operates correctly, the gate will move normally, otherwise proceed as follows;

02. Within 3 seconds, activate the control again and keep it activated;

03. After approximately 2 seconds, the gate will perform the required movement in “hold-to-run” mode; i.e. the gate will continue to move only as long as the control is activated.

IMPORTANT! – If the safety devices are out of use, it is advisable to have them repaired as quickly as possible by a qualified technician.

• Testing, periodic maintenance and any repairs must be documented by the person performing the operations and the relevant documents must be kept by the system owner. The only operations that can be performed by the user are to clean the photocell lenses (use a soft and slightly damp cloth) and remove any leaves or stones that may obstruct the automation. **Important** – To prevent the door from being activated accidentally, before proceeding release the automation manually (as described in the relevant manual).

• **Maintenance:** Regular maintenance (at least every 6 months) is needed to keep the level of safety constant and to ensure the maximum durability of the entire automation. **Checks, maintenance and repairs must be performed exclusively by qualified personnel.**

• **Disposal:** At the end of the automation’s lifetime, ensure that it is disposed by qualified personnel and that the materials are recycled or scrapped according to current local standards.

• **If the automation has been blocked by a “Block automation” command:** after sending a command, the gate does not move and the flashing light emits 9 short flashes.



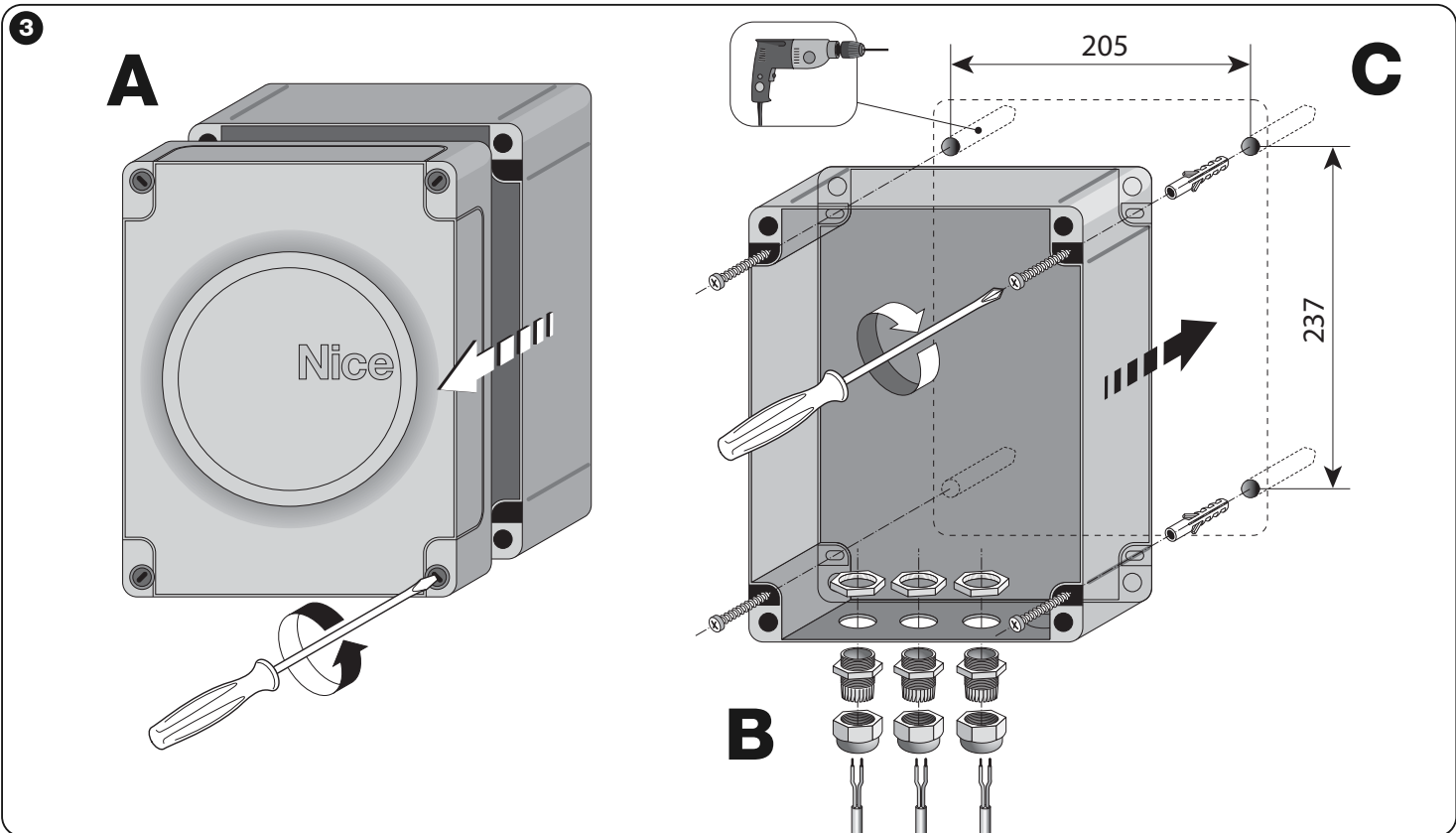
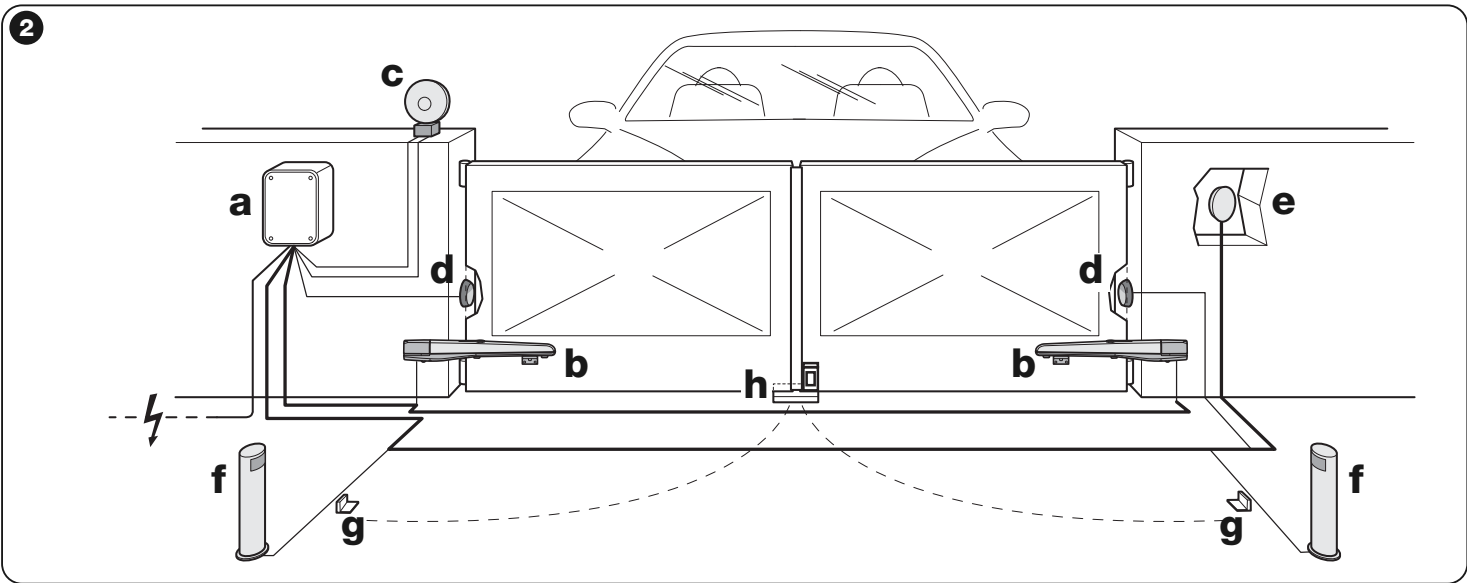
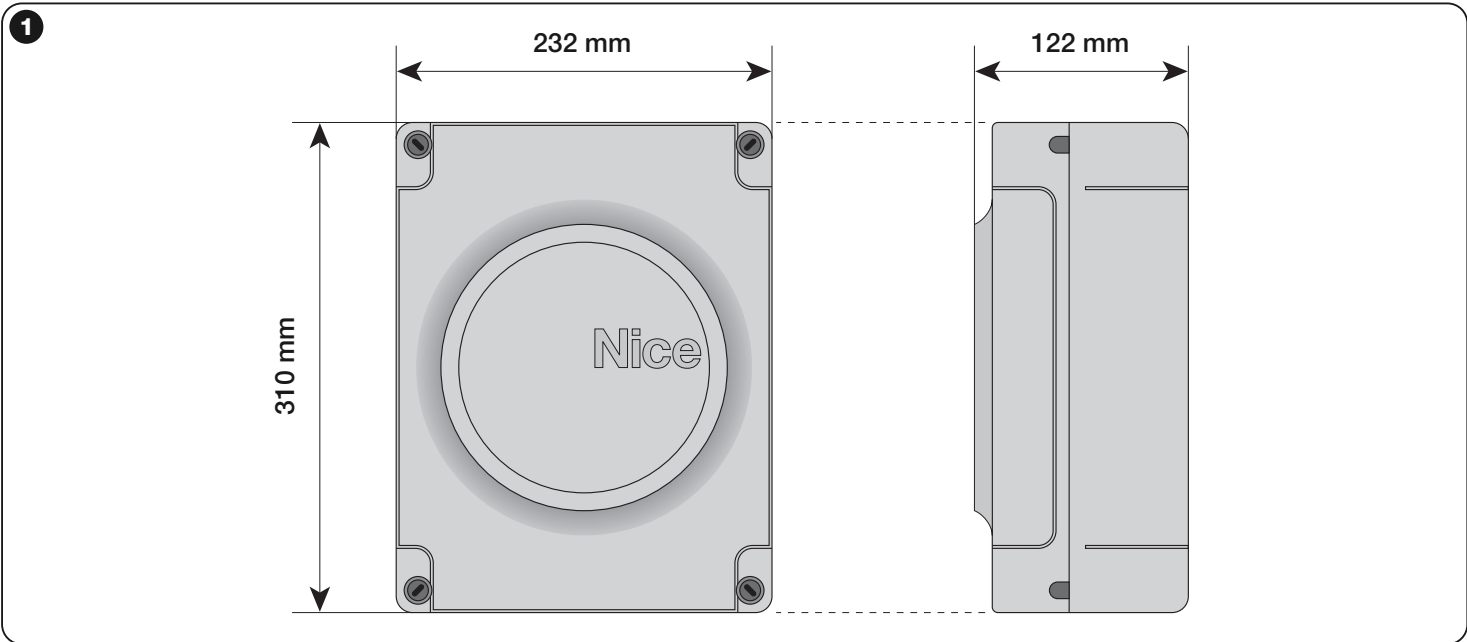

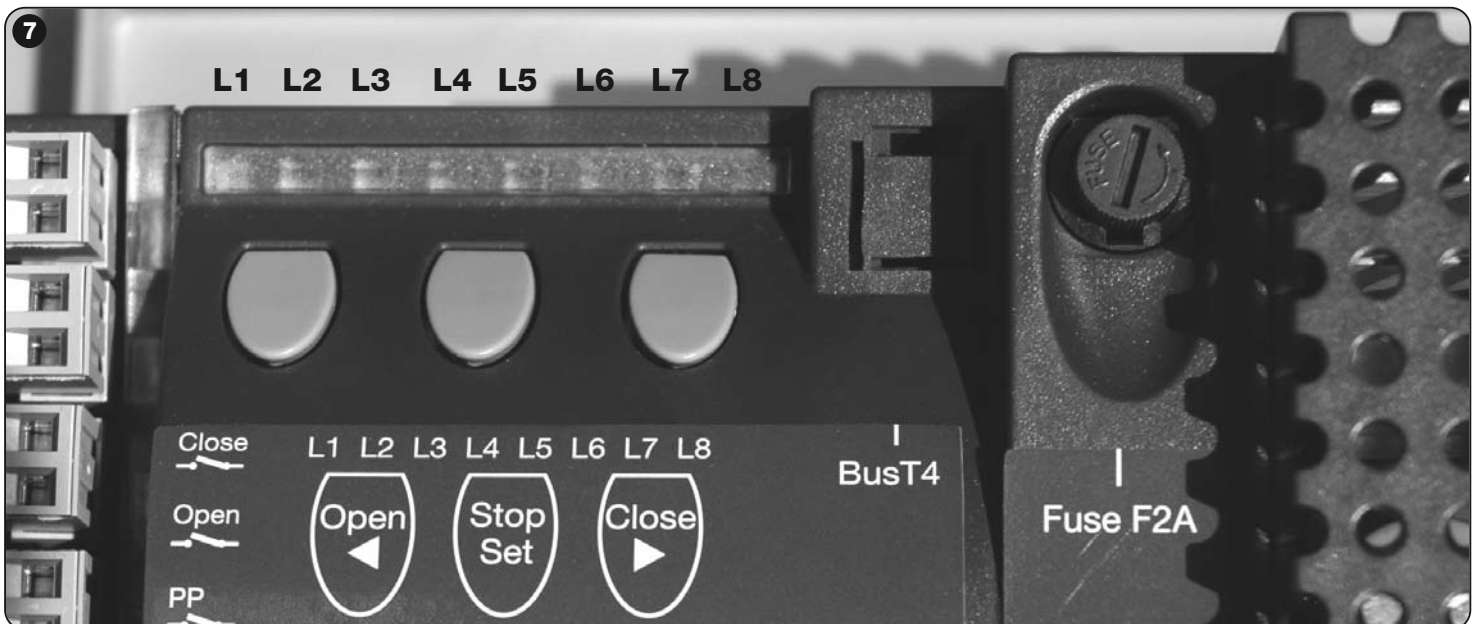
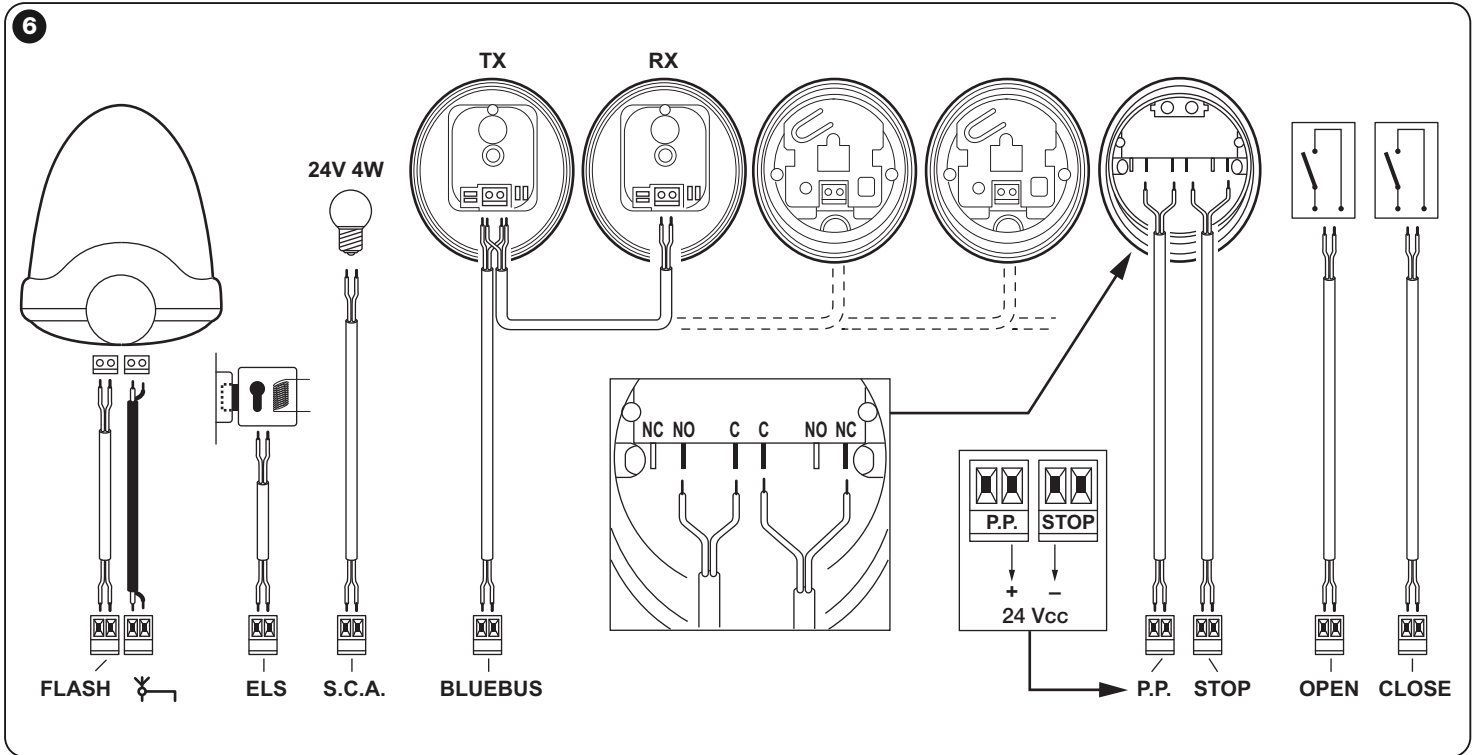
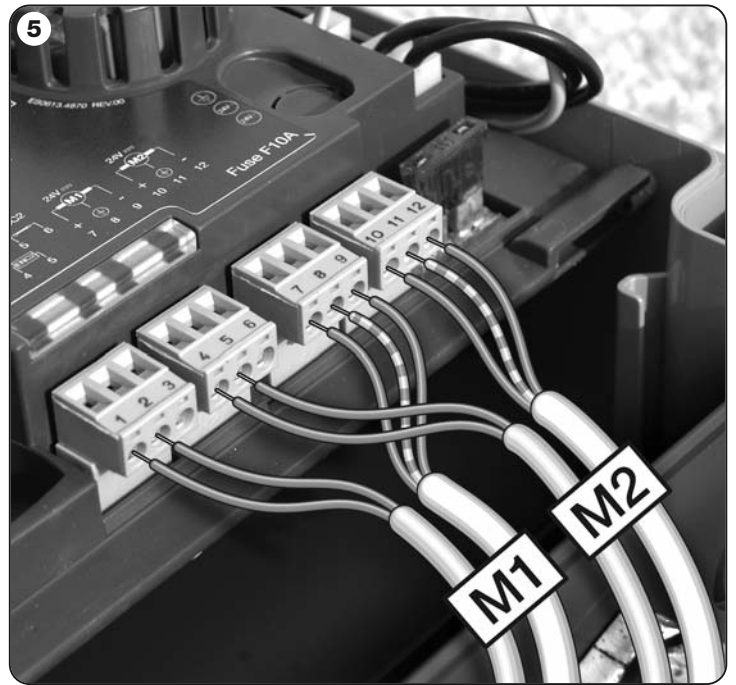
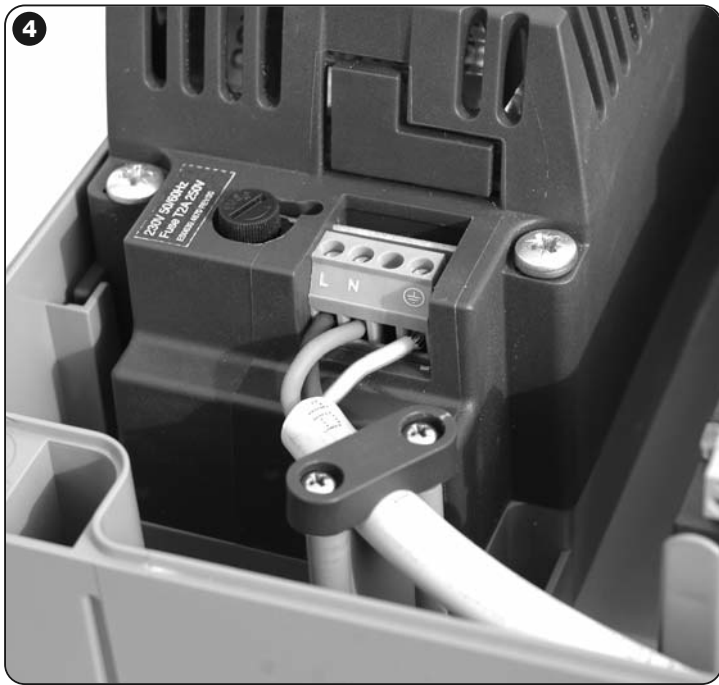

8

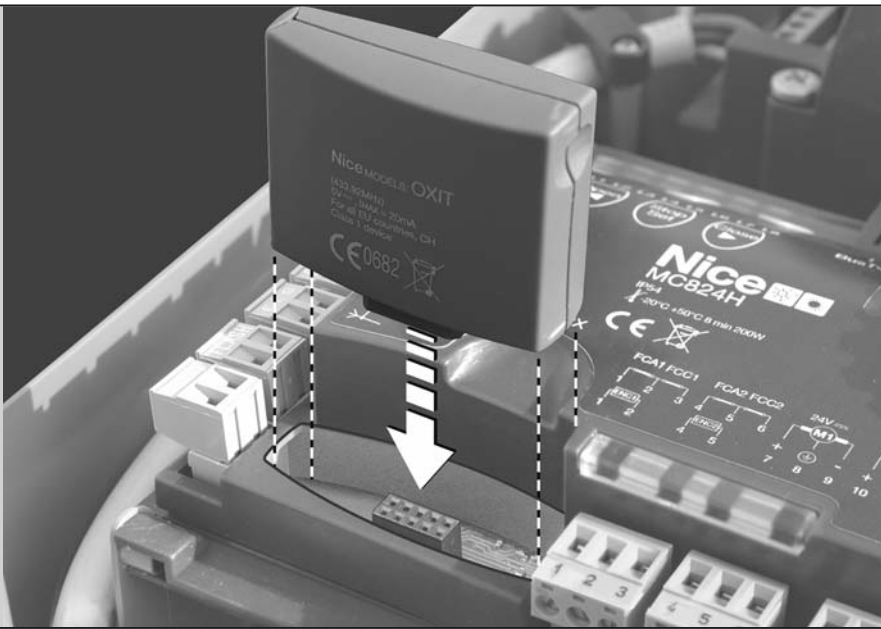

9

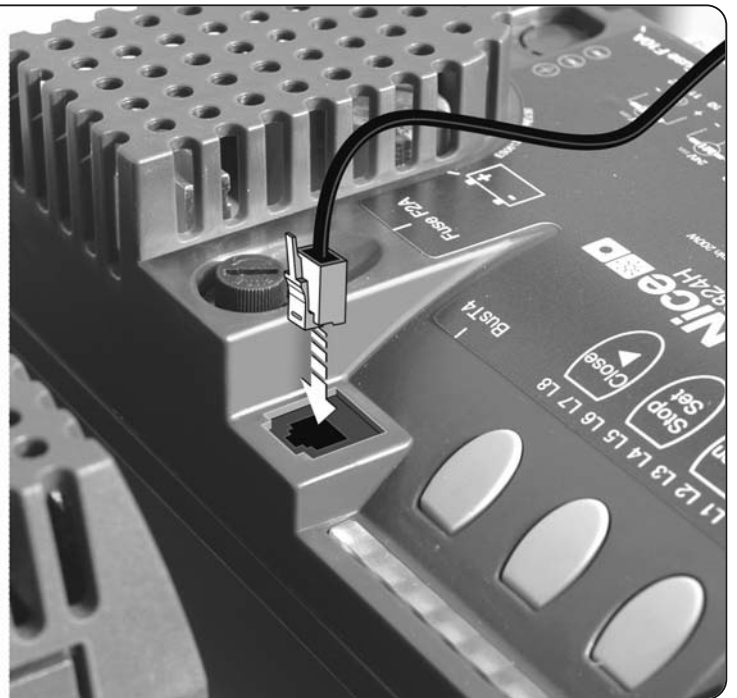

10

