

C 14 / C 15

GB Instructions for Initial Operation and
Wiring Scheme Manual
Door Operator for Industrial Use

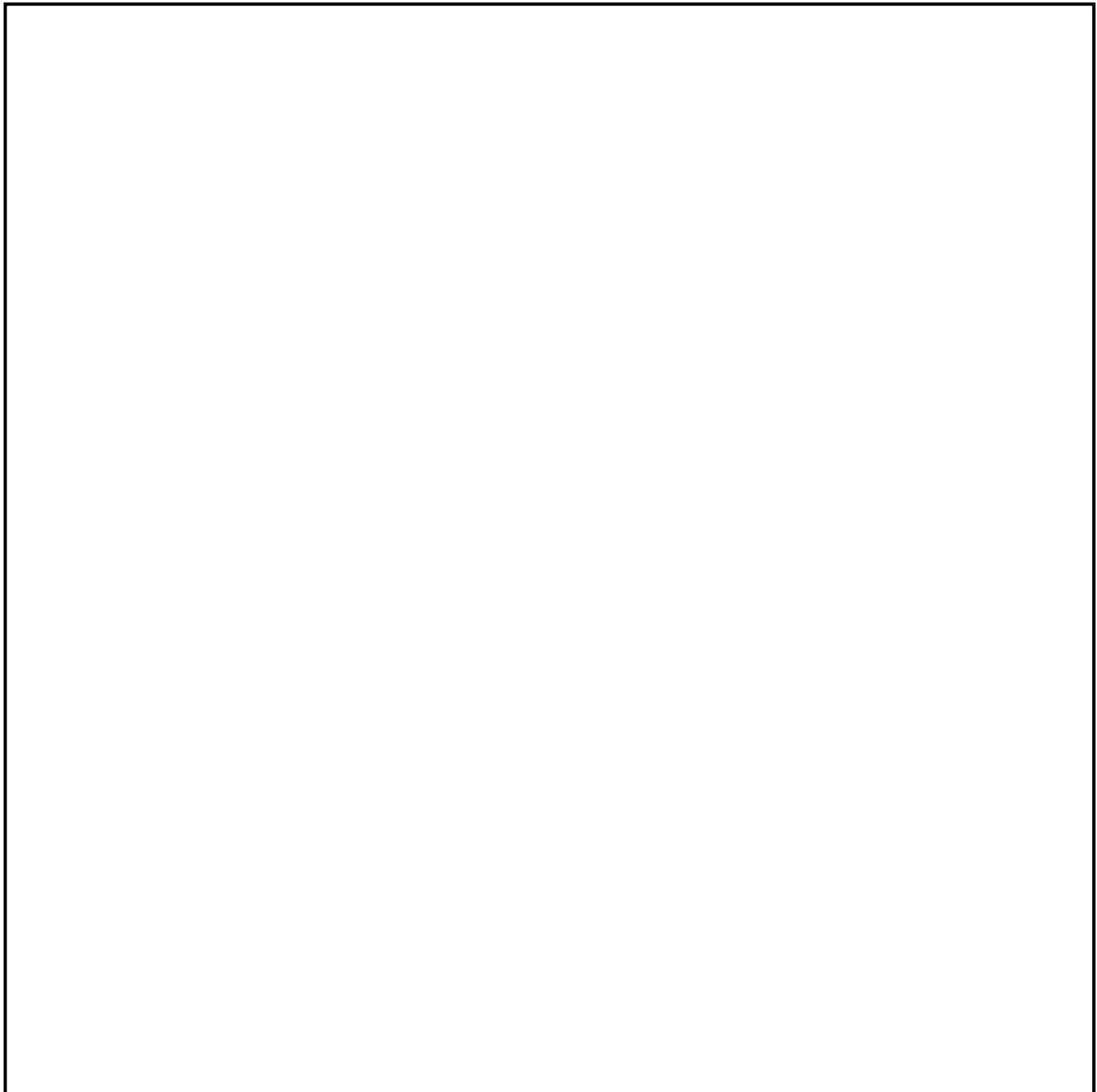

Please keep these instructions for further reference.

1. Contents

Chapter	Page
1. Contents	2
2. Meaning of symbols	3
3. Pictures to control unit C 14 / C 15	5
4. Important security notes	6
5. Initial operation of control unit C 14 / C 15	
5.1 Connection of membrane keypad 'Command 612'	8
5.2 Control unit — door leaf connection	9
5.3 First operation check	10
5.4 Setting the reference point	12
6. Display functions and programming possibilities	
6.1 Summary of display functions programming possibilities	13
6.2 Programming of operator's basic functions	16
6.3 Programming of extended operator's functions	19
7. Connection of closing edge safety device	25
8. Connection and initial operation of the extensions	
8.1 Remote control	27
8.2 External control elements (description of function)	28
8.3 External photocell	30
8.4 Travel limit signals (relay) and connection of signal lights	32
9. Error messages	33
10. Appendix	
10.1 Wiring diagram: mains/motor connection of control unit C 14	34
10.2 Wiring diagram: mains/motor connection of control unit C 15	35
10.3 Test instructions	36

2. Meaning of symbols



Warning! Risk of personal injury!

There follow important safety advice which must be followed in order to prevent personal injuries!



Attention! Risk of material damage!

There follow important safety advice which must be followed in order to prevent material damage!



Operational check:





















After connecting and programming most of the control elements, it is advisable to test the function of the control unit. Any fault can then be detected immediately and time is saved in trouble-shooting.



Advice / Tip

2. Meaning of symbols

Symbols of control unit, operator etc.:

	On, mains voltage		RPM sensor
	Impulse		To control unit
	Malfunction		Cable slack switch
	Open		Connection lead
	Close		Wicket door switch
	Power limit		Automatic timer
	Stop		Lighting
	External control elements		
	Electronic aerial		
	External photocell		
	Transmitter (optosensor, photocell)		
	Receiver (optosensor, photocell)		
	Closing edge safety device		

3. Pictures to control unit C 14 / C 15

Overview of door and surrounding area:

- A Membrane keypad
- B Connections control unit in motor
- C Ref. switch
- C Site electric socket CEE standard 16 A
- E Door leaf connection

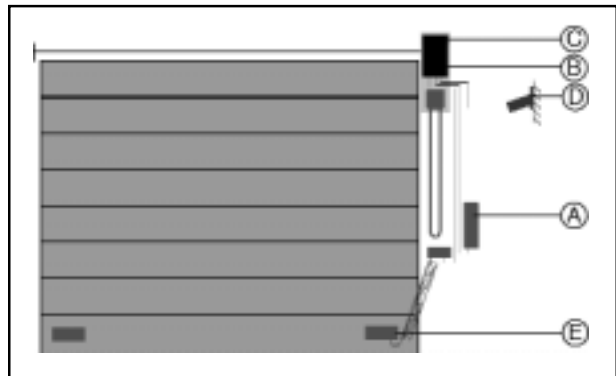

Fig.1: Overview of door and surrounding area

Key switch:

- 0 red OFF
- I blue ON

Control lights:

- 1. Photocell
- 2. OPEN travel limit
- 3. Automatic timer
- 4. CLOSE travel limit
- 5. Reference point
- 6. Malfunction
- 7. Impulse
- 8. Voltage

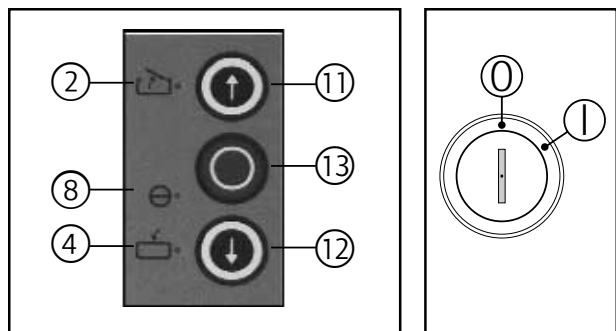

Fig.2: Membrane keypad and key switch

Control elements:

- 10. PROGRAMMING button
- 11. OPEN button
- 12. CLOSE button
- 13. STOP button

Plug connections:

- 25. X31 Closing edge safety device
- 27. X10 External control elements
- 28. X20 External photocell

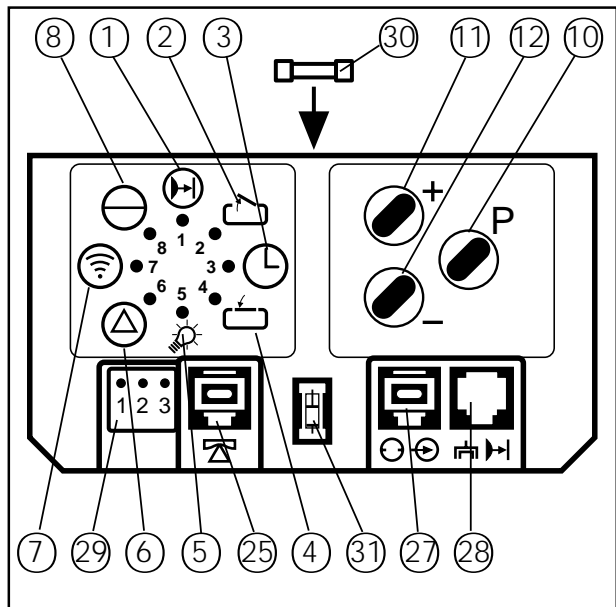

Fig.3: Overview on control buttons

- 29. X2c External control elements
- 30. F1 Fuse max 4A MT (only C 15)
- 31. S8 programming button SKS Test (set to position "off")

4. Important safety advice

This control unit may only be connected and put into operation by qualified and suitable trained specialist personnel. For the purpose of this description qualified and suitable trained specialist personnel are persons who are adequately instructed or supervised by qualified electricians and are thus in a position to recognize the hazards that electricity can cause. Moreover, they must hold qualifications consistent with the work being carried out. This presupposes in particular

- knowledge of applicable electro-technological regulations,
- training in the use and maintenance of adequate safety equipment,
- first aid training.



Attention!

Before carrying out any cabling work, it is essential to disconnect the control unit from the mains supply.

- Observe local safety regulations!
- Always lay mains cable and control cable separately.
Control voltage 24 V DC.



Attention!

Before putting the control unit into operation, it is essential to ensure, that there are no persons or objects within the door's area of operation, since a number of settings set the door in motion!

- All available emergency command devices must be tested prior to initial operation.
- The door operator must be installed with the door closed!
- After installation and initial operation, those persons or their representatives responsible for operating the door system must be shown how the door system works!
- No cables should be fed into the top of the control unit!
- For technical reasons, the first time the control unit is switched on, the door opens fully.

4. Important safety advice



Attention!

Special note for installation according to protection category IP 65: At the very latest following initial operation, the cable with plug allowing connection to the mains must be replaced by a fixed direct mains connection. At the same time a mains isolator switch must be fitted.



Attention!

Non-compliance with this warning and safety instructions can lead to personal injury and material damage.

5. Initial operation of control unit C 14 / C 15

5.1 Connection of membrane keypad 'Command 612'

Function:

By means of membrane keypad Command 612 (Art.-No. 153 810) the door can be travelled to direction OPEN or CLOSE and it can be stopped. The integrated key switch makes it possible to switch off the control unit.

Connection:

- Unscrew all four screws in upper part of housing.
- Fix the bottom part of housing to the wall at a well reachable place near door.
- Insert the enclosed system cable between bottom part of housing and wall.
- Remove the short circuit plugs from socket X10 of control unit (A1).
- Connect membrane keypad (A2) and control unit acc. to fig. 4.
- Close housing of membrane keypad.
- Set key switch to ON position (blue mark).

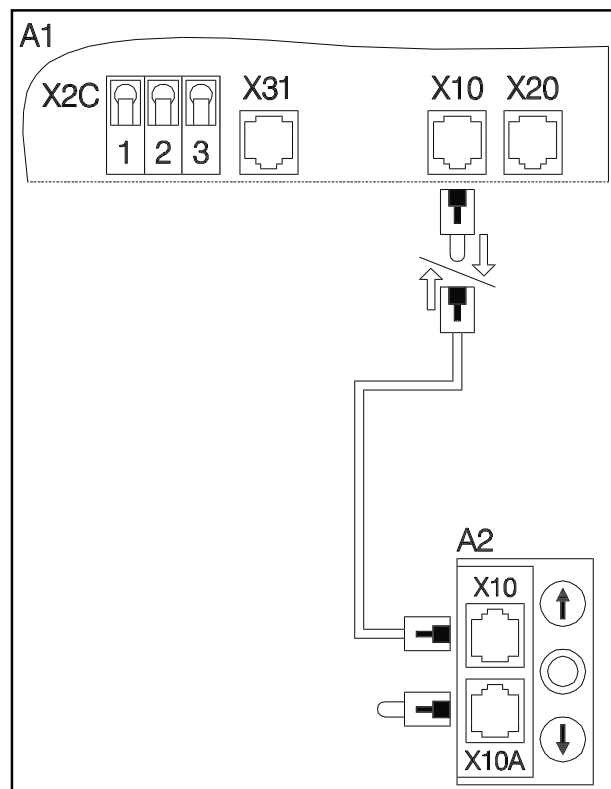

Fig. 4: Connection of membrane keypad

5. Initial operation of control unit C 14 / C 15

5.2 Control unit — door leaf connection



Attention!

The control unit features a static current circuit. If this static current circuit is interrupted, power operation of the door is no longer possible. Elements within this static current circuit are e.g. the cable slack switch, the wicket door switch and cable safety switch. If these elements are not available, insert enclosed short-circuit plug into socket **X31**.

Connection:

- For power supply connections please see fig. 5.



Advice:

Please also connect according to fig. 5, even if you want to put a door system with closing edge safety device into operation. The optosensors (transmitter and receiver) will be installed later.

5. Initial operation of control unit C 14 / C 15

Legend:

Switches (system plugs):

S5	Wicket door switch
S6	Cable slack switch
S7	Night lock

Switches (terminal screw connections):

S5a	*	Wicket door switch
S6a	*	Cable slack switch
S6b	◆	Cable safety device

Plug connections:

X31	Closing edge safety device (in control unit)
X71A	Wicket door contact
X71B	Cable slack switch
X71C	Night lock
X73	Connection cable
X74	◆ Optosensor transmitter

Terminal blocks:

X7C	Coiled cable
X7H	Static current circuit
X7L	Cable slack switch
X7V	◆ Connection terminal

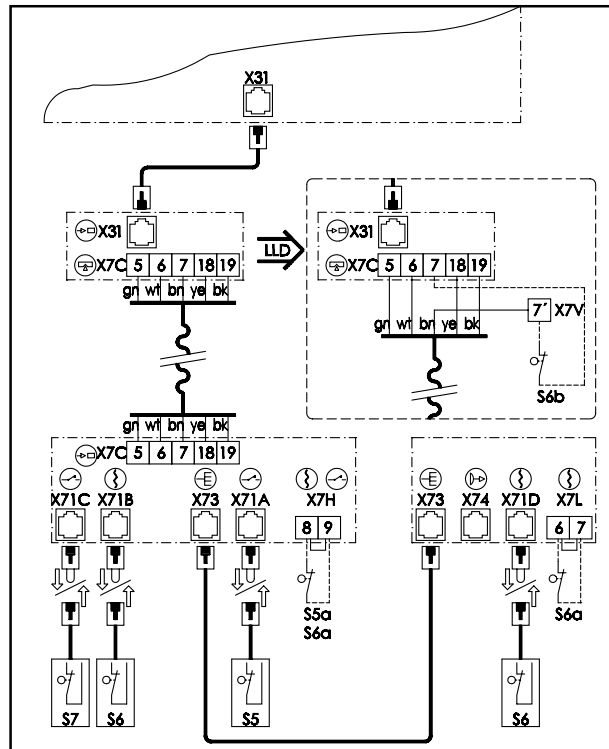
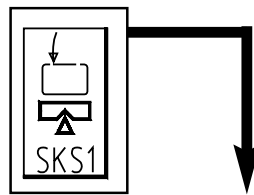

Fig. 5: Control unit - door leaf connection

* If connected, the short-circuit bridge must be removed

◆ If available

5.3 First operational check

- Insert the control unit mains plug into a site electric socket in accordance with CEE standard 16 A.
- Check that the power supply at this socket corresponds to the voltage indicated on the rating plate of the control unit and also that its protection category complies with the local regulations.

5. Initial operation of control unit C 14 / C 15

- If the control unit is to be connected directly to the mains, a mains isolator switch will have to be installed.
- For C 14: Make sure that the field rotates clockwise.



Operational check

Mains connection and cabling of operator:



Attention!

With the following settings it is important to ensure that the door is NEVER allowed to open or close fully. Halt the door at least 50 cm before it reaches its mechanical travel limits by pressing the STOP button (13).

- Half open the door by hand.
- Switch ON at the mains.
 - The VOLTAGE control light (8) should light up.
 - > If not, look up section 'no voltage' in the test instructions.
- Press the OPEN button (11).
 - The door should open
 - > If the door doesn't move: look up section 'no reaction on IMPULSE' in the test instructions
 - > The door closes: Press STOP button, reverses the rotary field.



Operational check

Current static circuit:

- Actuate each safety element separately.
 - Power operation of the door should now no longer be possible.
 - > If this is not the case, check the electrical connection of the respective safety element.
- Disconnect from mains supply.

5. Initial operation of control unit C 14 / C 15

5.4 Setting the reference point

- Move the door by hand to CLOSE position.
- Open cover on door operator.

- Unlock the switching spindle by moving the red no-load lever (32) to the front and by pushing the inner door link disk (33) in direction of spindle (see fig. 6).

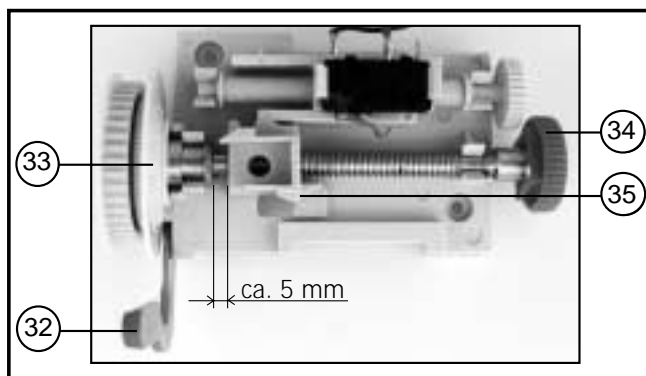

Fig. 6: Setting the reference point (door is closed)

- Turn the knurled wheel (34) clockwise until the carriage (35) is approx. 5 mm before the chamfered end of the switching spindle (see fig. 6).

- Re-lock the door link disk and secure it by a hearable engaging of the no-load lever.
- Now the door has to be opened fully by hand.

- Now turn with the small knurled wheel (37) the adjusting spindle, until the reference point switch (38) is actuated by the carriage (36) (see fig. 7). Then turn the small knurled wheel (37) 1 - 2 rounds counterclockwise.

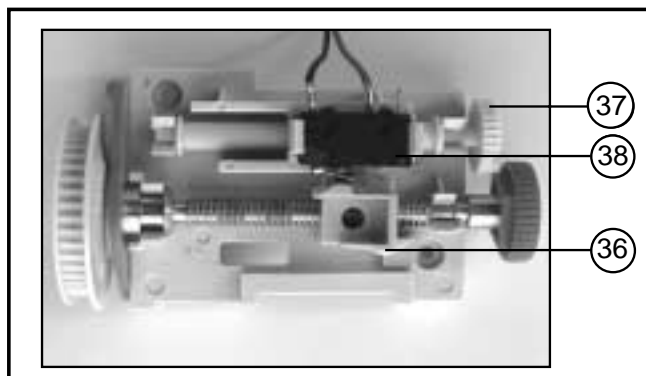

Fig. 7: Setting the reference point (door is opened)

- Close the cover again.
- Move the door, power-operated, to the set travel limit CLOSED.

6. Display functions and programming possibilities

6.1 Summary of display functions and programming possibilities

Display functions

After connecting to mains supply the control unit performs a self-check. (all control lights light up for approx. 2 sec.).

- See fig. 3 / page 5

Error messages

If control light MALFUNCTION (6) lights up, after shortly pressing button P (10) the respective error number is indicated (LED's flash irregularly).

The error number is calculated by adding the flashing figures.

- See section 9, error numbers, page 33.

Programming of the operator's basic functions

Press button P (10) longer than 2 sec. The control unit changes from operating mode to programming mode of basic functions, LED 1 flashes. All other LED's are glowing. Release button P .

By pressing buttons \oplus (11) or \ominus (12) you can change settings in programming menu and save with button P . (If button P is actuated without change of settings by means of buttons \oplus or \ominus , the programming menu is skipped and the settings remain unchanged.) After last programming menu the programming of the operator's basic functions is completed, recognizable by all LED's going out in sequence 8 - 1.

Programming of extended operator functions

Press button P (10) longer than 10 sec. The control unit changes from operating mode to programming level for extended operator functions, LED 8 flashes quickly, all other LED's are glowing. **Hold button** P pressed and select by means of button \oplus (11) or button \ominus (12) the desired programming level (LED of level flashes quickly, all other LED's are glowing). Now button P may be released. The first programming menu of the desired level is selected (LED1 flashes, all other LED's are glowing). Changes of settings in programming menu are made by actuating button \oplus or \ominus and can be saved by pressing button P . (If button P is actuated without change of settings by means of buttons \oplus or \ominus ,

6. Display functions and programming possibilities

the programming menu is skipped and the settings remain unchanged.) After the last programming menu the programming of the extended operator function is completed, recognizable by all LED's going out in sequence 8 - 1.

Advice for programming

The programmed data cannot be deleted, they are only overwritten. If the control unit is in programming mode and neither programming button (⊕, ⊖, ⊕) is pressed within 30 sec. the programming is cancelled. The control unit returns to operating mode. The control light MALFUNCTION (6) flashes, by shortly pressing button ⊕ error number 7 is indicated (= programming cancelled).

6. Display functions and programming possibilities

Explanation of the extended operator functions:

Programming level	Functions	Explanation
8. level Operating modes. Table: see page 19.	<ul style="list-style-type: none"> - Press and hold OPEN. - Press and hold CLOSE. - Impulse commands. - Direction commands (push button OPEN or CLOSE). - Impulse function OPEN. 	<p>The operator travels after start to travel limit OPEN.</p> <p>The operator travels after start to travel limit CLOSE.</p> <p>A running operator may be stopped or not by command.</p> <p>A running operator may be stopped or not by command.</p> <p>Reversion or priority OPEN.</p>
3. level Automatic timer. Table: see page 20/21.	<ul style="list-style-type: none"> - Toraufzeit - Warning time - Warning before start - Premature closing after passing photocell 	<p>Time, in which the door is open, before door closes automatically.</p> <p>Time period, in which signal light flashes, before door closes automatically.</p> <p>Time period, in which signal light flashes, before door starts to move.</p> <p>The door closes either after set open time or premature after passing photocell.</p>
5. level Operator lighting / signal lights. Table: see page 22/23	<ul style="list-style-type: none"> - Lighting time - Signal lights - Lighting 	<p>(Connection of lighting is not possible).</p> <p>The signal lights flash or glow at power operated movement of the door</p> <p>(Connection of lighting is not possible).</p>
6. level Reversion modes Table: see page 24	<ul style="list-style-type: none"> - Photocell OPEN - Photocell CLOSE - Closing edge safety device OPEN - Closing edge safety device CLOSE - Power limit OPEN - Power limit CLOSE 	<p>Adjustable for STOP, short or long reversion.</p> <p>Adjustable for STOP, short or long reversion.</p> <p>Adjustable for STOP, short or long reversion.</p> <p>Adjustable for STOP, short or long reversion.</p> <p>Adjustable for STOP, short or long reversion.</p> <p>Adjustable for STOP, short or long reversion.</p>

6. Display functions and programming possibilities

6.2 Programming of operator's basic functions

1. Programming of external photocell

Actuate button **P** for approx. 2 sec. until LED 1 flashes and all others are glowing.

By pressing button **+** connection of external photocell is possible.

-> LED 1 glows.

By pressing button **-** the operator can be used without external photocell.

-> LED 1 flashes.

Connection and activation of external photocells, see point 8.3, page 30.

Save by pressing button **P**.

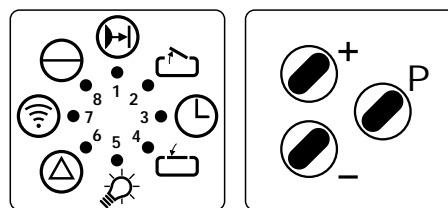

2. Programming of travel limit OPEN

LED 2 flashes and all others are glowing. Travel door to travel limit OPEN by pressing button **+** or **-** (operator runs without press and hold) and save by pressing button **P**.

3. Programming of travel limit CLOSE

LED 4 flashes and all others are glowing. Travel door to travel limit CLOSE by pressing button **+** or **-** (operator runs without press and hold) and save by pressing button **P**.

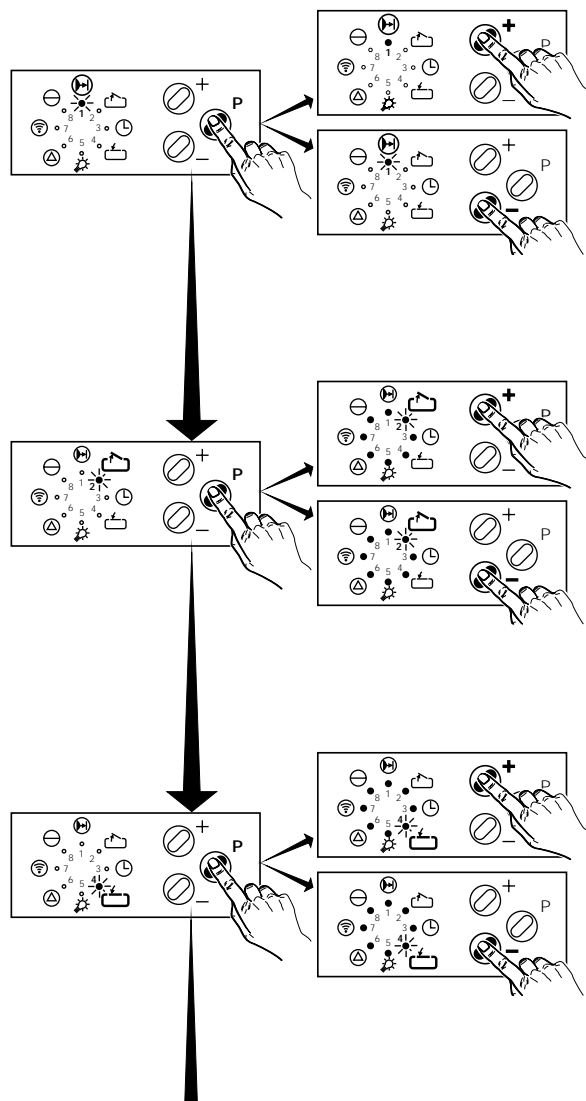

6. Display functions and programming possibilities

4. Programming of power limit

OPEN

LED's 2 and 6 flash and all others are glowing.

Pressing buttons \oplus or \ominus to adjust the power limit in steps* from 1 (most sensible value) to 16. Save by pressing button \textcircled{P} .

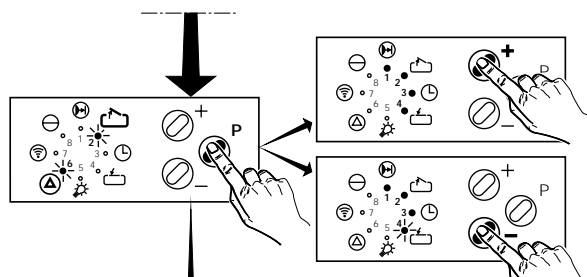

5. Programming of power limit

CLOSE

LED's 4 and 6 flash and all others are glowing.

Pressing buttons \oplus or \ominus to adjust the power limit in steps* from 1 (most sensible value) to 16. Save by pressing button \textcircled{P} .

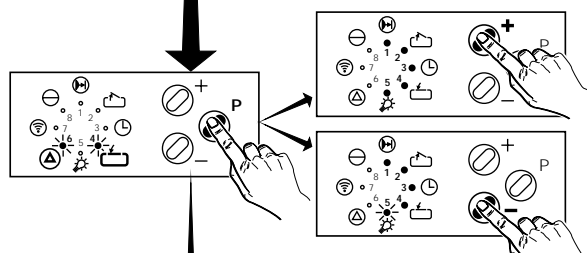

6. Programming of remote control

LED 7 flashes and all others are glowing.

For connection of electronic aerial see point 8.1, page 27.

Actuate the respective button of coded hand transmitter, until LED 7 flashes quickly and save by pressing button \textcircled{P} .

Programming of operator's basic function is completed, recognizable by all LED's going out in sequence 8 - 1.

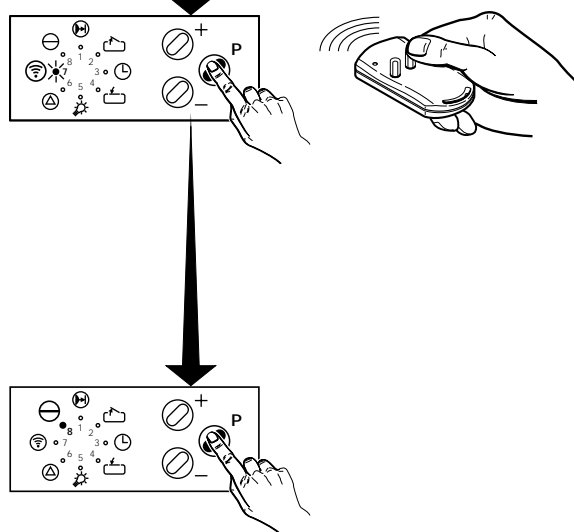

6. Display functions and programming possibilities



Attention!

Set the power limit to be as sensitive as possible!
The effectivity of power limit has to be checked regularly.

* Indication of steps:

LED1 flashes	=	step 1
LED1 glows	=	step 2
LED 1 glows, LED 2 flashes	=	step 3
...		
LED's 1 to 8 glow	=	step 16

6. Display functions and programming possibilities

6.3 Programming of extended operator functions

Level 8: Operation modes

		BUTTON \ominus				BUTTON \oplus				
		1	2	3	4	5	6	7		
BUTTON P										
		Menu 1	Press and hold for direction OPEN							
			OFF	ON						
				X						
		Menu 2	Press and hold for direction CLOSE							
	OFF	ON								
		X								
Menu 3	Impulse commands stop a running operator									
	NO	YES								
	X									
Menu 4	OPEN / CLOSE - commands stop a running operator									
	NO	YES								
		X								
Menu 5	Impulse functions									
	NORM Reversion	OPEN Direction OPEN								
		X								

Legend:

- LED flashes
- LED ON
- LED OFF

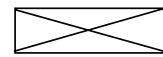

supplied by factory









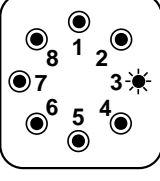
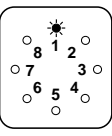
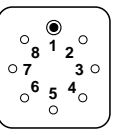

not possible

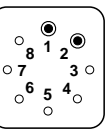
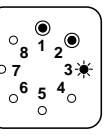
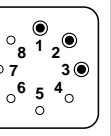
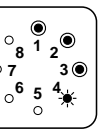
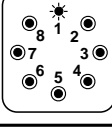
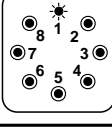
6. Display functions and programming possibilities

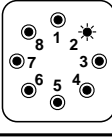
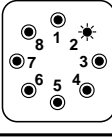
6.3 Programming of extended operator functions

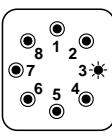
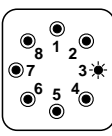
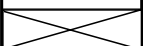
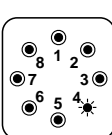
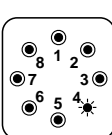
Level 3: Automatic timer

		← BUTTON 						
		1	2	3	4	5	6	7
								
BUTTON P ↓	Menu 1	OPEN time						
		Closing function deactivated	5 sec.	10 sec.	15 sec.	20 sec.	25 sec.	30 sec.
								
	Menu 2	Warning time						
		Closing function deactivated	2 sec.	5 sec.	10 sec.	15 sec.	20 sec.	25 sec.
								
	Menu 3	Warning before start						
		0 sec.	1 sec.	2 sec.	3 sec.	4 sec.	5 sec.	6 sec.
								
	Menu 4	Premature closing after passing photocell						
		NO	YES					
								

6. Display functions and programming possibilities

BUTTON (+) →								
8	9	10	11	12	13	14	15	16
35 sec.	40 sec.	50 sec.	80 sec.	100 sec.	120 sec.	150 sec.	180 sec.	255 sec.
30 sec.	35 sec.	40 sec.	45 sec.	50 sec.	55 sec.	60 sec.	65 sec.	70 sec.
7 sec.								



Legend:

- LED flashes
- LED ON
- LED OFF
- supplied by factory
- not possible

6. Display functions and programming possibilities

6.3 Programming of extended operator functions

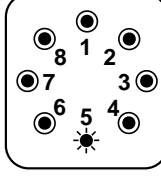
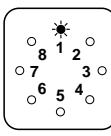
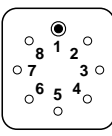
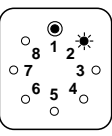
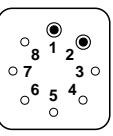
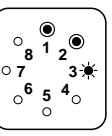
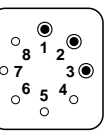
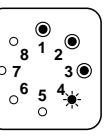
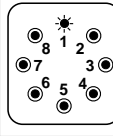
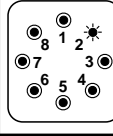
Level 5: operator lighting / signal lights

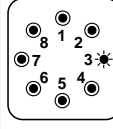
		← BUTTON (−)						
		1	2	3	4	5	6	7
								
BUTTON P	Menu 1	Light time (connection of lighting is not possible)						
								
	Menu 2	Signal lights						
		external external glowing	external external flashing					
								
	Menu 3	Lighting (connection of lighting ist not possible)						
								

6. Display functions and programming possibilities

BUTTON (+) →								
8	9	10	11	12	13	14	15	16

Legend:

- ✱ LED flashes
- LED ON
- LED OFF
- supplied by factory
- not possible

6. Display functions and programming possibilities

6.3 Programming of the extended operator functions

Level 6: Reversion modes

	BUTTON \ominus				BUTTON \oplus		
	1	2	3	4	5	6	7
Menu 1 Power limit for OPEN direction	STOP	SHORT reversion	LONG reversion	NOT available			
Menu 2 Power limit for CLOSE direction	STOP	SHORT reversion	LONG reversion	NOT available			
Menu 3 Photocell for OPEN direction	STOP	SHORT reversion	LONG reversion	NOT available			
Menu 4 Photocell for CLOSE direction	STOP	SHORT reversion	LONG reversion	NOT available			
Menu 5 Closing edge safety device OPEN direction	STOP	SHORT reversion	LONG reversion	NOT available			
Menu 6 Closing edge safety device CLOSE dir.	STOP	SHORT reversion	LONG reversion	NOT available			

Legend:

- LED flashes
- LED ON
- LED OFF
- supplied by factory
- not possible

7. Connection of closing edge safety device

Function:

The closing edge safety device monitors the bottom door seal. If whilst closing the door meets with an obstruction, the closing edge safety device automatically halts the door and lifts it to clear the obstruction.

Connecting the closing edge safety device:

Insert the optosensors into the bottom door seal and connect them according to fig. 8.

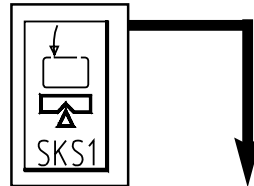

Legend:

Switches (system plugs):

- S5 Wicket door switch
- S6 Cable slack switch
- S7 Night lock

Switches (screw terminals):

- S5a * Wicket door switch
- S6a * Cable slack switch
- S6b ◆ Cable safety device

Plug connections:

- X31 Closing edge safety device (in control unit)
- X71A Wicket door contact
- X71B Cable slack switch
- X71C Night lock
- X71D Cable slack switch
- X72 Optosensor receiver
- X73 Connection cable
- X74 Optosensor transmitter

Terminal blocks:

- X7C Coiled cable
- X7H Static current circuit
- X7L Cable slack switch
- X7V ◆ Connection terminal

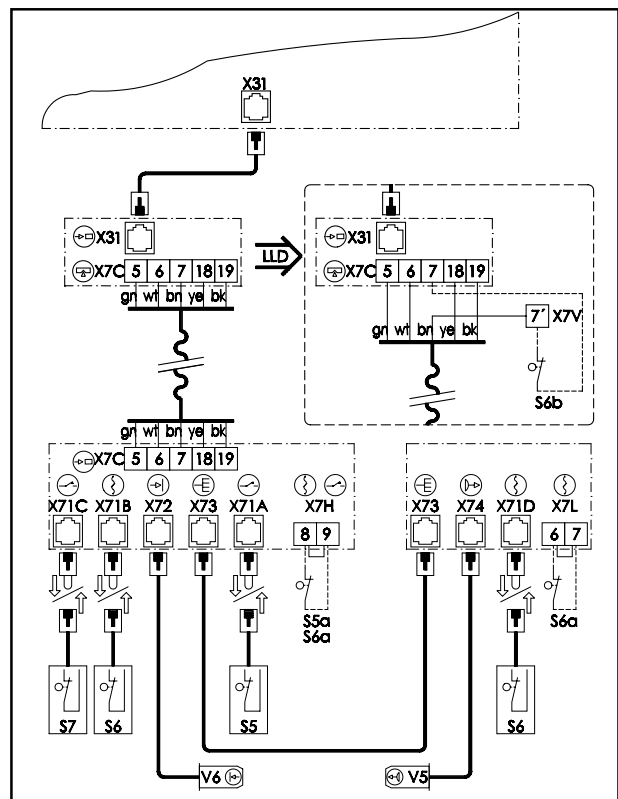

Fig. 8: Wiring diagram closing edge safety device

Optosensors:

- V5 Transmitter
- V6 Receiver

* If connected, the shortcircuit bridge must be removed.

◆ If available

7. Connection of closing edge safety device

Displays on the optosensor circuit board:

GREEN LED:	Voltage
YELLOW LED	Static current circuit closed (should go out when cable slack or wicket door device actuated)
RED LED	Optosensor function indicator (should go out when light beam interrupted)



Operational check of the closing edge safety device:

- Switch on at the mains.
- Operate the door to arrive at its OPEN travel limit
- Press the CLOSE button (12).
 - The door should close by press and release.
 - > If this is not the case, check the optosensor (see test instructions).
- Whilst the door is still closing, press the bottom door seal together.
 - The door should come to a halt, then rise a short distance.
 - > If this is not the case, check the optosensor (see test instructions)
- Switch off at the mains.



Operational check of the optosensors:



Attention!

The function of optosensors should be checked at least once a year in order to guarantee safe operation of the door system.

Tests instructions:

- Interrupt the light path in the bottom door seal; this can be achieved by deforming the seal or by removing the transmitter or receiver bung.
- It should now not be possible to subsequently close the door by press and release.
- Make the light path in the bottom door seal clear again.
- It should now be possible again to close the door by press and release.

8. Connection and initial operation of the accessories

8.1 Remote control

Connection of the electronic aerial

- Connect the electronic aerial to socket **X20** in the control unit.



Advice:

When installing, make sure that the aerial is properly aligned in order to achieve the best possible range.

(Beware of the fact that metal parts have a shielding effect.)

Adapting the control unit to a hand transmitter

See 6.2, step 6. Programming of remote control page 17.

In case of power failure the coding remains stored.



Operational check:

- Operate the hand transmitter from a distance of approx. 15 m
 - The door should now start to move
 - > If this is not the case, see test instructions 'remote control'.

8. Connection and initial operation of the accessories

8.2 External control elements

Function:

The operation of the door system takes place by the commands **OPEN**, **CLOSE**, **STOP** resp. **IMPULSE**. For this purpose the respective control elements of Command range (push button, key switch and code keypad) can be connected via **system plug**. For **conventional** cabling of the impulse button there is a connection with screw clamps.

In detail the commands cause the following actions:

- OPEN :** The door is opened. If the door is in end position OPEN and the automatic timer function is on, the open door time is started again.
- CLOSE :** The door is closed. If the door is in end position OPEN and the automatic timer function is on, the open door time is terminated.
- STOP :** A running door is stopped. It can no longer be moved.
- IMPULSE :** The door is opened (exception: if the door is in end position OPEN, it is closed).
If the door is in end position OPEN and the automatic timer function is on, the open door time is started again.

Conventional connection:

- Install the impulse button (A2) to a well accessible place to the wall near the door.
- Connect the impulse button via terminal X2C, contact 1 and 2, to the control unit (A1), as shown in fig. 9
- Test the function of the impulse button.

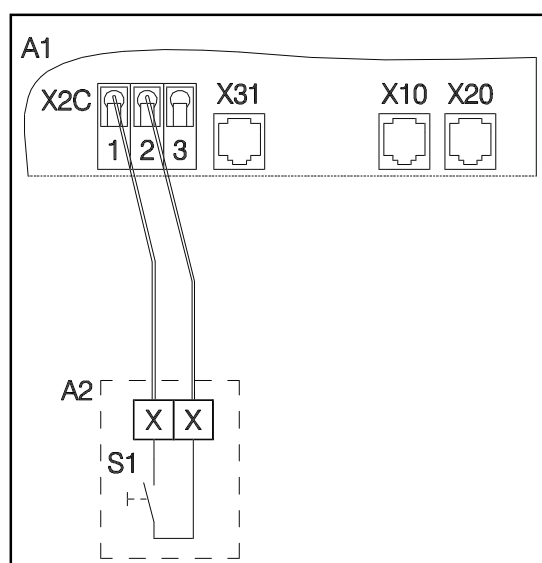

Fig. 9: Connection impulse button

8. Connection and initial operation of the accessories

Connection with system plugs:

- Install the control element (A3, A4 or A5) to a well accessible place to the wall near the door.
- Remove the short circuit plug from socket X10A of the membrane keypad Command 612 (A2).
- Connect the control element to the system socket X10A of the membrane keypad as shown in fig. 10
- Test the function of the control element.

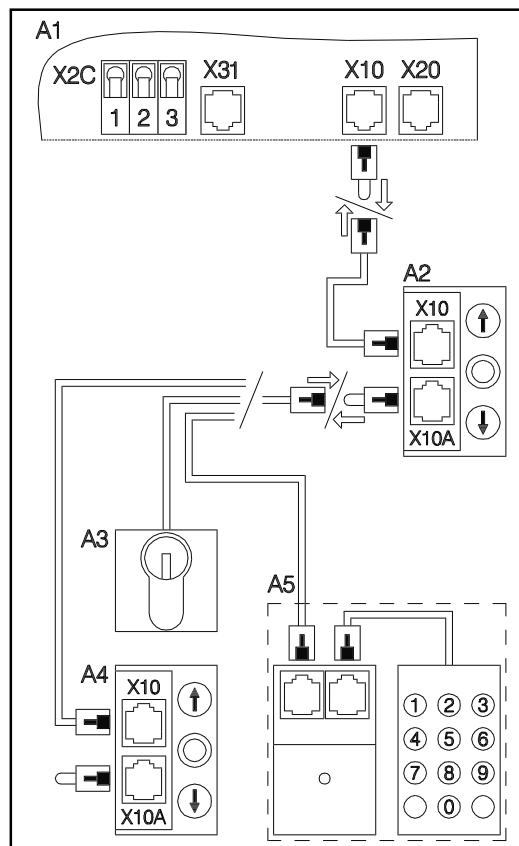

Fig. 10: Connection of control elements



Advice!

You can also connect every single control element directly to the control unit (A1) via socket X10.

If two or more control elements have to be connected to the membrane keypad, the "joint for plug system RSK", Art.-No.: 151 228 and a flat cable, Art.-No. 562 759 are required.

8. Connection and initial operation of the accessories

8.3 Connection of external photocell

Function:

The external photocell monitors the passway of the door. If the door is closing and there is any obstruction in the passway during closing, the door opens fully again.

If the automatic timer is activated, the open door phase is increased by activation of the photocell.



Attention!

When the door is closed, the photocells are switched off.
To adjust the photocell, open door fully or partially.

Connection of photocells: Special 613 , Art.-No. 153 550
Special 614 , Art.-No. 152 675
Special 615 , Art.-No. 152 703

- Program control unit for the operation with an external photocell (see page 16, step 1).
- Connect the photocell to socket **X20** in the control unit.
Cabling of photocell is made as shown in fig. 11.
More detailed information can be found in installation instruction of photocell.

8. Connection and initial operation of the accessories

Connection plan: photocell

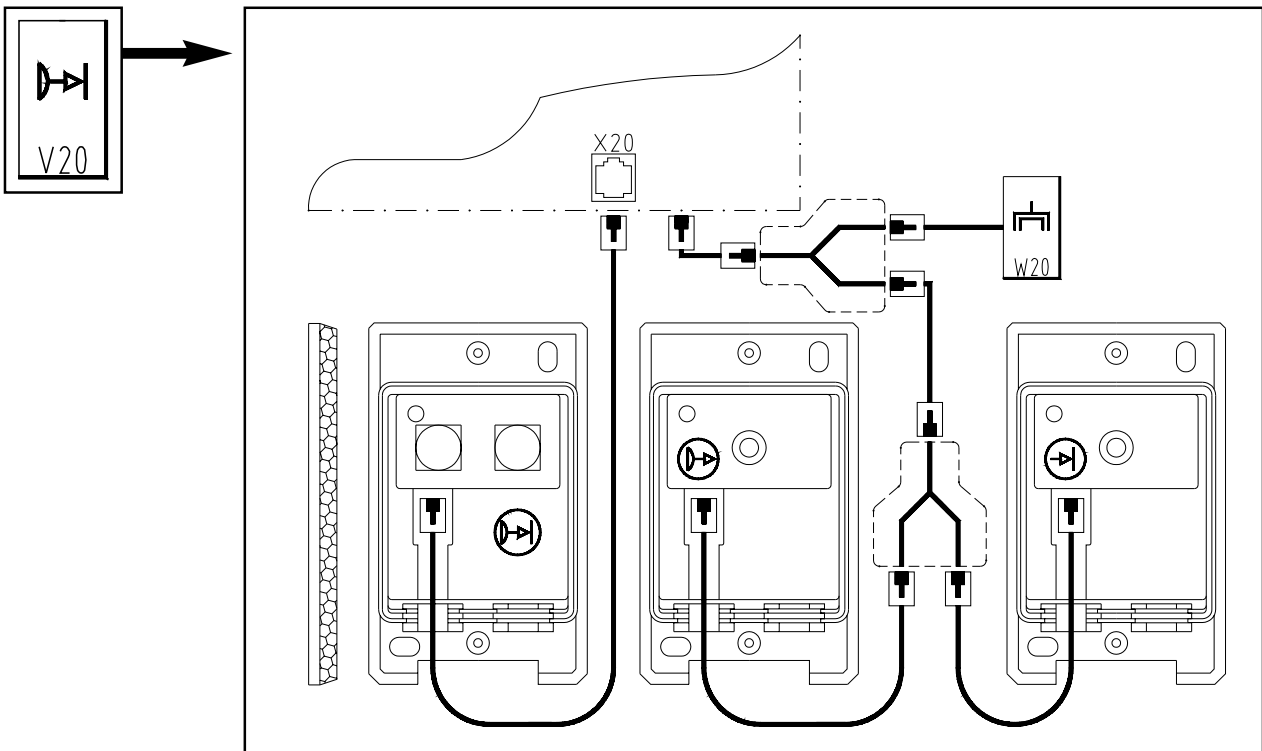

Fig. 11: Connection of photocell

In case there is already an aerial unit connected to this socket, then an adapter (coupling for plug system, 3-pin, Art.-No. 562 856) and a flat cable (Art.-No. 562 759) have to be connected according to above wiring diagram.



Operational check:

- Operate the door to CLOSE.
- Interrupt the photocell's light beam.
 - The door must stop and then open again fully.
 - > If this is not the case, check programming of photocell.

8. Connection and initial operation of the accessories

8.4 Travel limit signals (relay)

Function:

On reaching the OPEN / CLOSE travel limits, the corresponding relay connects.

and signal light connection

Function:

The signal lights flash during power operation of the door. When the automatic timer is activated, the signal lights are flashing additionally during warning time.

Connection of retrofit kit OPEN / CLOSE light

(Art.No. 152 137)

- Connect both sockets X10 of control unit and retrofit kit with a system cable, as shown in fig. 12.
- Connect the control elements, e.g. membrane keypad Command 612, to socket **X10A** of the retrofit kit.

Legend:

H1	Signal light CLOSE
H2	Signal light OPEN
H41	Signal light DRIVE IN (orange)
H43	Signal light DRIVE OUT (orange)
K1	Relay CLOSE
K2	Relay OPEN
K3	Relay SIGNAL LIGHTS

Plug connections:

X8A	Travel limit relay
X8B	Signal light relay
X10	Control unit
X10A	External control elements

- - - - - site cabling

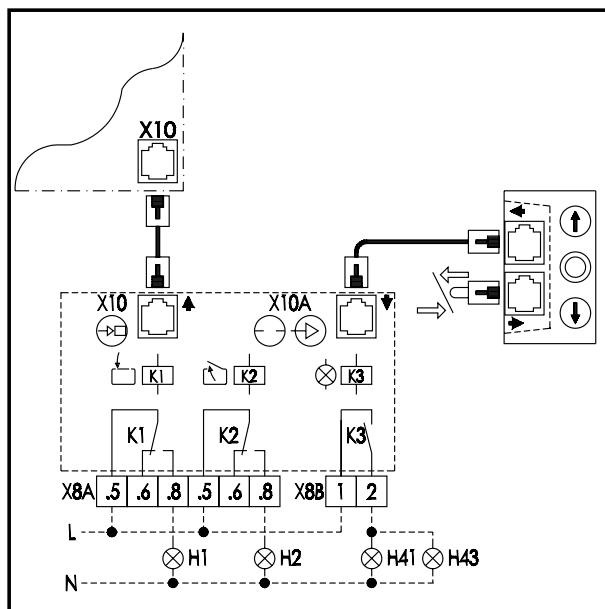

Fig. 12: Trave limit signal and signal light

9. Error messages

- If control LED MALFUNCTION (6) is flashing, the referring error number is indicated on shortly pressing button $\text{\textcircled{P}}$ (10) - LED's are flashing irregularly.
- The error number is calculated by adding of the flashing figures.

Error characteristic	Error number	LED flashing irregularly
Photocell actuated	6	LED 6
Programming cancelled	7	LED 7
RPM sensor defective	9	LED 8 + 1
Power limit	10	LED 8 + 2
Excess travel stop	11	LED 8 + 3
Testing closing edge safety device not o.k.	13	LED 8 + 5
Testing photocell not o.k.	15	LED 8 + 7
Static current circuit interrupted	36	LED 1 - 8

10.1 Connecting plan: Mains supply of control unit C 14



Attention! Observe local safety regulations! Always lay mains cables and control cables separately!
External voltage at the terminals **X4** will completely destroy the electronics!

Legend:

- A1 Control unit
- K1 OPEN inversion relay
- K2 CLOSE inversion relay
- M1 Motor with thermal overload protection
- R1 Short circuit protection (PTC)
- S0 Main switch*
- S10 Emergency manual operation switch
- S10a Maintenance release switch
- S21 RPM sensor
- S22 Reference point sensor
- T1 Transformer
- W1 Mains lead
- X2 Terminal mains lead
- X3 Terminal motor
- X4 Terminal sensor motor

* on site

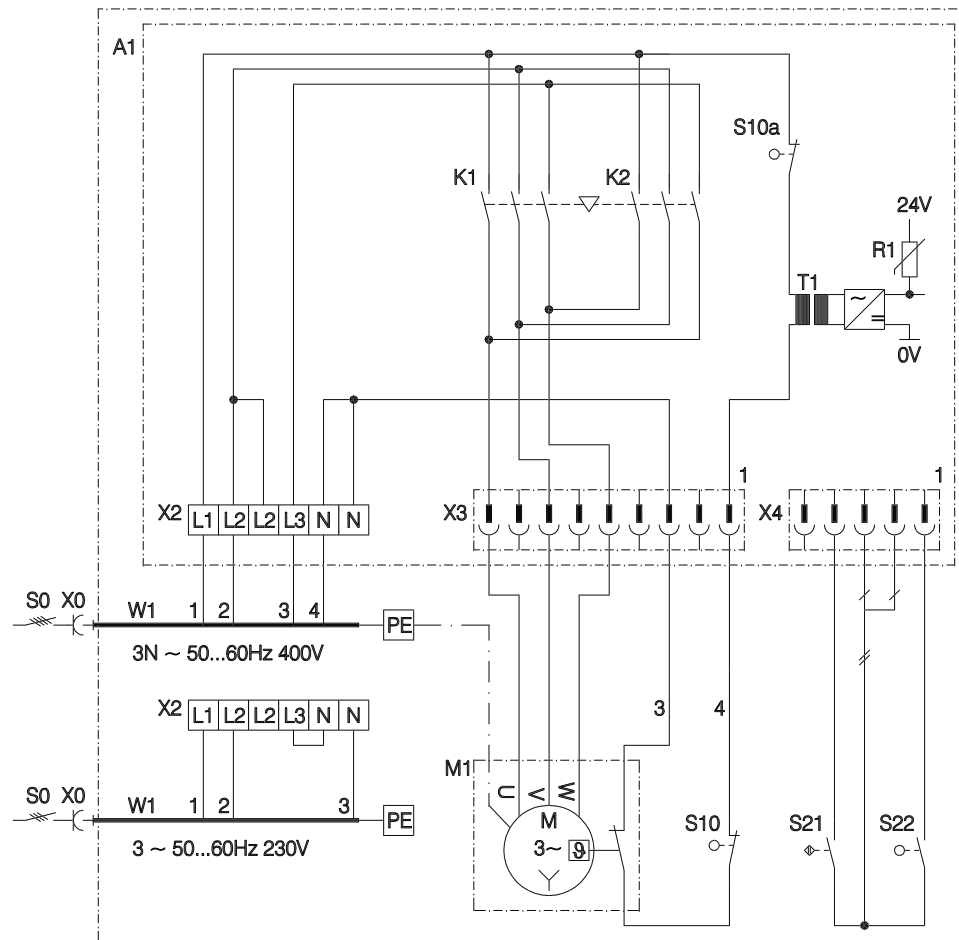

Fig. 13: Mains supply of control unit C 14

10.2 Connecting plan: Mains supply of control unit C 15



Attention! Observe local safety regulations! Always lay mains cables and control cables separately!
External voltage at the terminals **X4** will completely destroy the electronics!

Legend:

- A1 Control unit
- F1 Fuse (max. 4A MT)
- K1 OPEN relay
- K2 CLOSE relay
- K3 LIGHT relay
- M1 Motor with thermal overload protection
- R1 Short circuit protection (PTC)
- S0 Main switch*
- S10 Emergency manual operation switch
- S10a Maintenance release switch
- S21 RPM sensor
- S22 Reference point sensor
- T1 Transformer
- W1 Mains lead
- X2 Terminal mains lead
- X3 Terminal motor
- X4 Terminal sensor motor

* on site

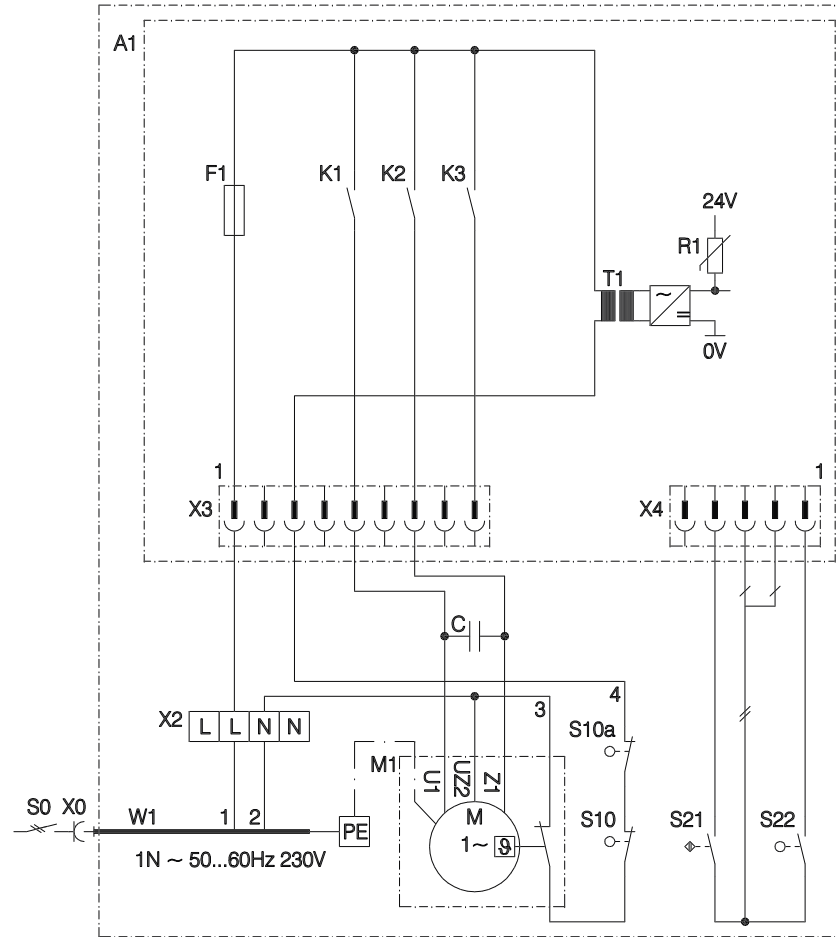

Fig. 14: Mains supply of control unit C 15

10. Appendix

10.3 Test instructinos

Error	Error message	Cause for error
<ul style="list-style-type: none">• No voltage.	<ul style="list-style-type: none">• Control light VOLTAGE does not light up.	<ul style="list-style-type: none">• No voltage......• Emergency hand chain not in home position.....• Operator disengaged......• Thermo overload protection in motor is active.
<ul style="list-style-type: none">• No reaction after IMPULSE.	<ul style="list-style-type: none">• Control light MALFUNCTION flashes. Error No. 36.	<ul style="list-style-type: none">• Control unit is locked (red mark)......• Static current circuit (control elements) is interrupted......• Static current circuit (door leaf) is interrupted.
<ul style="list-style-type: none">• Remote control.	<ul style="list-style-type: none">• Control light IMPULSE does not flash after given impulse on hand transmitter.	<ul style="list-style-type: none">• Electronic aerial not connected......• Wrong programming of hand transmitter coding......• Flat battery......

10. Appendix

Remedies

- Check voltage.
.....
 - Check main fuses in electric distribution and mains plug connections.
.....
 - Return the emergency hand chain to the home position (see installation instruction of operator).
.....
 - Engage the maintenance or quick release.
.....
 - Allow the motor to cool down.
.....
-
- Unlock the control unit (blue mark).
.....
 - Insert short-circuit plug or control element plug into socket **X10**.
.....
 - Check cable slack, wicket door and cable safety switch.
.....
-
- Connect aerial (s. page 27).
.....
 - Program new coding (see page 17).
.....
 - Insert new battery (9V, IEC 6F22 or 12V, A23).
.....

10. Appendix

Error	Error message	Cause for error
• Power limit.	• Control light MALFUNCTION. Error No.10.	• Power limit set too sensitively. • Door operation too sluggish.
• Door can only be opened.	• Control light MALFUNCTION flashes, error No. 15. • Control light REFERENCE POINT does not light up when passing the reference point.	• Photocell is programmed both no photocell is connected. • Wrong setting of reference point switch.
• Door can only be closed in dead man's mode.*	• Control light MALFUNCTION flashes, error No. 13. • Red control light on optosensor circuit board does not light up.	• Optosensor not connected. • Coiled cable defective. • Optosensors are not in bottom door seal or defective. • Bottom door seal is deformed.
• Operator starts up then stops.	• Control light MALFUNCTION flashes, error No. 9.	• RPM sensor defective.
• No function.	• Control lights 1 - 7 flash.	• Fault in control unit.

* if closing edge safety device is installed

10. Appendix

Remedies

- Set power limit less sensitively (see page 17).

-
- Have door system checked (greasing or similar).

-
- Check programming of photocell.

-
- Set reference point (see page 12).

-
- Install optosensor (see page 25).

-
- Check coiled cable and connections.

-
- Check installation of optosensors or replace them.

-
- Align bottom door seal or replace it.

-
- Have operator checked.

-
- Have control unit checked.
-

ENGLISH

Copyright.

No part of this manual may be reproduced without our prior approval.

Subject to alterations in the interests of technical progress.



Version: 08.2004
#61 657

1 - GB/KD 360197 - M - 0.5 - 0701