

SHUTTER B 2.0

ROLLER SHUTTERS CONTROL BOARD 100-250V AC 433MHZ



V elektroniki utripa rdeča dioda.

Control board for roller shutters from 100-250V AC, with multibrand and multifrequency receiver RX-Multi integrated (433 MHz frequency). Up/down input switches (configurable as dead man, direct order or sequential switch). Automatic closure and photo beam signal input available and lamp

Ni PP kontakta!!!

Pritisneš in držiš desni gumb "Learn", da zapiska 1x in spustiš ... pritisneš tipko na daljincu, zapiska ... daljinec je vnešen. Za drugega ponoviš postopek od začetka.

Vrata morajo biti zaprta!!! Prej s pomočjo kabla nastaviš končne pozicije.

Pritisneš in držiš desni gumb "Learn", da zapiska 2x in spustiš ... vrat se začnejo odpirati, ko se odprejo počakaj 4 sekunde in stisni "Learn" ... s tem ustaviš čas odpiranja(če čakaš 5 sekund se vklopi samozapiranje in šteje čas do naslednjega pritiska na tipko Learn), še enkrat pritisneš tipko "Learn" in vrata se začnejo zapirati. Ko se zaprejo počakaj cca 4 sec in ponovno pritisni tipko "Learn" ... s tem zaključis čas zapiranja in istočasno programiranje časov.

Pritisneš in držiš desni gumb "Learn", da zapiska 5x in spustiš ... RESET ... izbrisal si čase poti in vse daljince. Vrata moraš na novo sprogramirati. 8

DS052 SHUTTER 2.0

CONNECTIONS

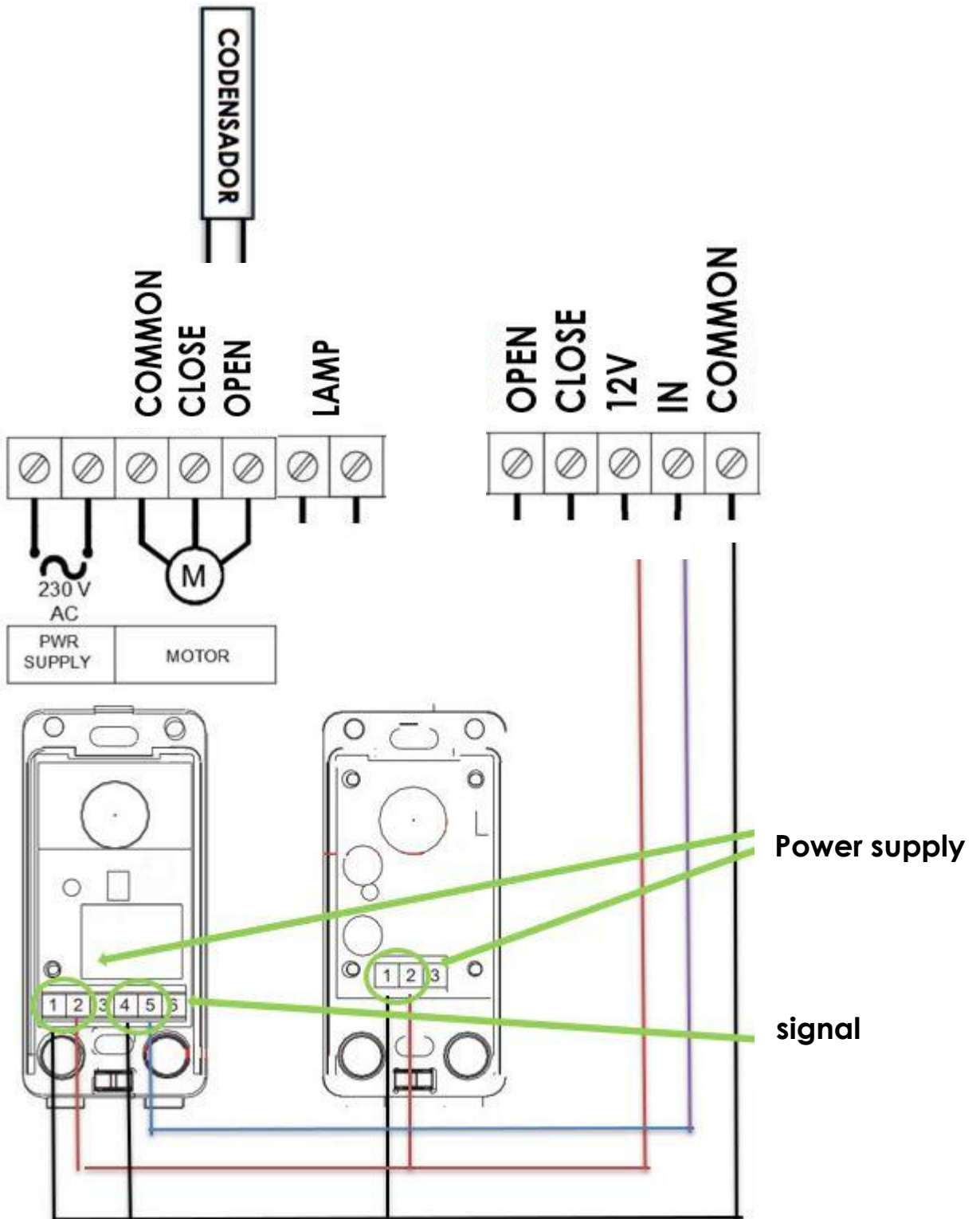

SHUTTER 2.0

NOTE:

The lamp work by 1 minute.

- Power supply accessories (terminals 12V DC and COMMON): connect to feed with direct current 12V to photocell.
- Open / Close button: connect 12V and Open / Close, as desired.
- Safety devices: connect the signal of return of the device to the board between the terminal of COMMON and IN.

DIP SET UP

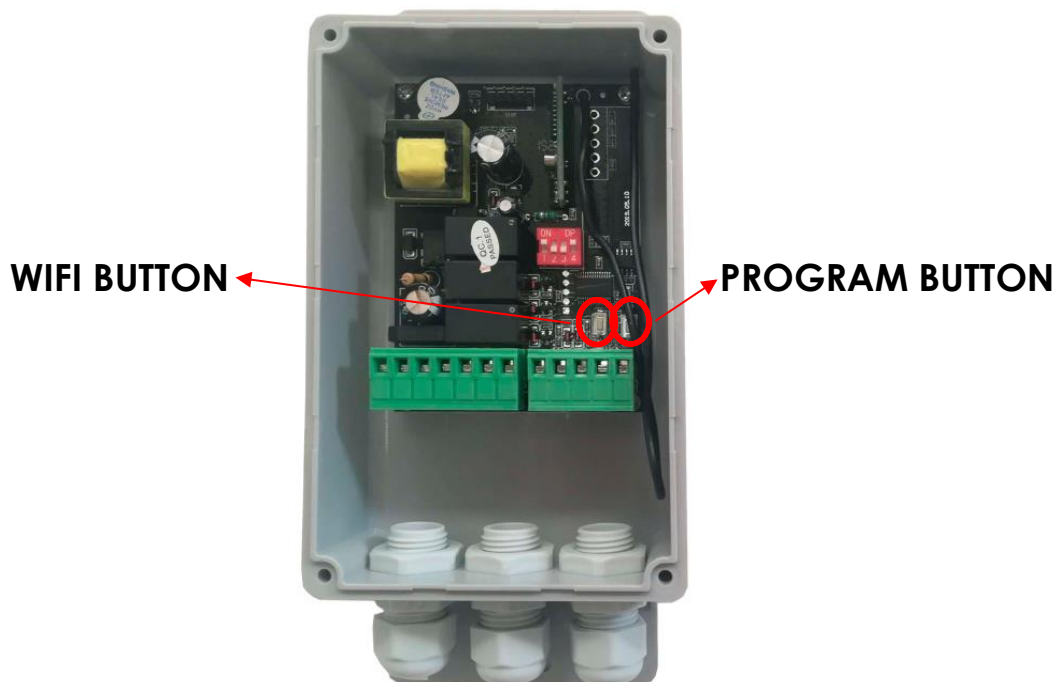

1 LIMIT SWITCHES /DEAD MAN

DS052 SHUTTER 2.0

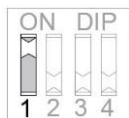

ON Dead man switch(at 12V, Opening and Closing terminals).

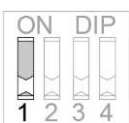

OFF Limit switches (at 12V, Opening and Closing terminals).

2 DEAD MAN IN OPENING MANEUVER (DIP 1 ON)

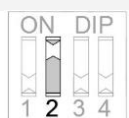

ON To start opening maneuver, is necessary to hold pressed the transmitter's button or the PROG switch. If the button is not held, maneuver will stop.



OFF Opening is set as direct order operation.

3 DEAD MAN IN CLOSING MANEUVER (DIP 1 ON)

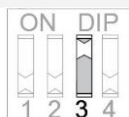

ON To start the closing maneuver, hold pressed the transmitter's button or the PROG button. If the button is not held, maneuver will stop.



OFF Closing is set as direct order operation.

4 PHOTOBREAM

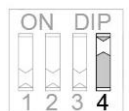

ON Photocell is disabled (It is not necessary to bridge the security input). Automatic closure is not available with this position.

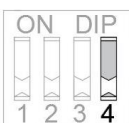

OFF Photobeam is enabled. This configuration allows the programming of optional automatic closure.

PROGRAMMATION

PROGRAMATION MENU

OPTION 1 –REMOTE MEMORIZATION MODE

Press LEARN button until 1 beep sounds, release the button, now you have to press the button in the original remote. It will beep again and then the remote is programmed.

SHUTTER 2.0

OPTION 2 - MANEUVERS TIME PROGRAMMING

Press LEARN button until 2 beeps sound that means it is on maneuvers time programming.

OPTION 3 - CHANNEL ERASE

Press LEARN button until 3 beeps sound that means it is on delete mode of programmed channel. Channel will be deleted.

OPTION 4 (DIP 1 ON)

UP-DOWN / SEQUENTIAL SWITCH

Press LEARN button, until it beeps 4 times, this means up/down option is on. When the button is released, it will automatically change to sequential switch and viceversa.

One short beep will indicate the up/down selection and a longer beep will indicate sequential switch selection.

OPTION 4 (DIP 1 OFF)

STEP BY STEP/INVERSION TO CLOSURE

Press LEARN button until it beeps 4 times. This means inversion to closure option has been selected. When releasing the button, menu changes to inversion to closure and viceversa.

One short beep means step by step selection and a longer beep means inversion to closure.

This option can ONLY be done with the transmitter

OPTION 5 - MEMORY ERASING

Press LEARN button until it beeps 5 times. This indicates the erasing mode is activated. When releasing the button all channels and remotes will be erased.

***Note: once the memory has been deleted, it is MANDATORY to repeat option 1 and 2 for the correct functioning of the control board.**

REMOTE PROGRAMMING

Select option 1 from the MENU (Press LEARN button until it beeps one time, this means it is on remote memorization mode).

DS052 SHUTTER 2.0

Press the button of the remote you want to use, 3 beeps will confirm it has been correctly memorized.

Control board exits automatically the memorization mode after four seconds or after pressing again LEARN button or the already programmed remote's button. The exit will be indicated by 3beeps.

MANEUVERS TIME PROGRAMMING

Before programming, check the correct installation of the limit switches (in case they are installed). The door must be closed.

The orders are given by pressing LEARN button or an already programmed remote.

1.Select Option 2 from the MENU. Press LEARN button until 2 beeps sound (maneuver time programming mode has been activated).

2.The door will start the opening maneuver. If limit switches have been selected, maneuver will stop once limit switches are activated, if not, the order must be given by you at the end of the maneuver.

3.Once opening maneuver finishes, control board awaits for an order to start closing maneuver. If activated within 5 seconds, manual mode will be activated; if activated after 5 seconds, automatic closing mode will be set up and the time elapsed from the end of opening to the start of the closing maneuver will be programmed as stand-by time.

***In case photobeam is DISABLED (DIP 4 ON):** Automatic closure is not available at programming maneuver option from the menu (due to security reasons).

***In case photobeam is ENABLED (DIP 4 ON) but not installed by the user:**The control board will block itself and no closure maneuver will be allowed, showing to the user there is a mistake and its programming.

4.The door will only stop by pressing the limit switches when these are installed. Then, 1 beep will indicate the end of the closing maneuver and the exit from the timing programming.

Repeat the procedure if you need to modify the programming.

Attention: IT WILL ONLY ADD 433Hz CONTROLS (KELOS CODE)

SHUTTER 2.0

TECHNICAL CHARACTERISTICS	
Power supply	100 – 250V AC +/- 10%
Motor power	736 W / 1 CV
Max. Functioning time	2 min.
Max. Closing time	2 min.
Code combinations	72.000 billion codes
Number of codes	31 codes
Code programming	Self-taught
Sensitivity	Better than -100dBm
Distance	Max 70 meters
Aerial	Incorporated
Working temperature	-20°C to 85 °C